



Department
for Education

National Centre
for Excellence in the
Teaching of Mathematics



Mathematics guidance: key stages 1 and 2

**Non-statutory guidance for the national
curriculum in England**

Year 5

June 2020

What is included in this document?

This publication provides non-statutory guidance from the Department for Education. It has been produced to help teachers and schools make effective use of the National Curriculum to develop primary school pupils' mastery of mathematics.

Who is this publication for?

This document is one chapter of the full publication *Mathematics guidance: key stages 1 and 2 Non-statutory guidance for the national curriculum in England*.

An overview of the ready-to-progress criteria for all year groups is provided below, followed by the specific guidance for year 5.

To find out more about how to use this document, please read the introductory chapter.

Ready-to-progress criteria: year 1 to year 6

The table below is a summary of the ready-to-progress criteria for all year groups.

Strand	Year 1	Year 2	Year 3	Year 4	Year 5	Year 6
NPV	1NPV-1 Count within 100, forwards and backwards, starting with any number.		3NPV-1 Know that 10 tens are equivalent to 1 hundred, and that 100 is 10 times the size of 10; apply this to identify and work out how many 10s there are in other three-digit multiples of 10.	4NPV-1 Know that 10 hundreds are equivalent to 1 thousand, and that 1,000 is 10 times the size of 100; apply this to identify and work out how many 100s there are in other four-digit multiples of 100.	5NPV-1 Know that 10 tenths are equivalent to 1 one, and that 1 is 10 times the size of 0.1. Know that 100 hundredths are equivalent to 1 one, and that 1 is 100 times the size of 0.01. Know that 10 hundredths are equivalent to 1 tenth, and that 0.1 is 10 times the size of 0.01.	6NPV-1 Understand the relationship between powers of 10 from 1 hundredth to 10 million, and use this to make a given number 10, 100, 1,000, 1 tenth, 1 hundredth or 1 thousandth times the size (multiply and divide by 10, 100 and 1,000).
		2NPV-1 Recognise the place value of each digit in two-digit numbers, and compose and decompose two-digit numbers using standard and non-standard partitioning.	3NPV-2 Recognise the place value of each digit in <i>three</i> -digit numbers, and compose and decompose <i>three</i> -digit numbers using standard and non-standard partitioning.	4NPV-2 Recognise the place value of each digit in <i>four</i> -digit numbers, and compose and decompose <i>four</i> -digit numbers using standard and non-standard partitioning.	5NPV-2 Recognise the place value of each digit in numbers with up to 2 decimal places, and compose and decompose numbers with up to 2 decimal places using standard and non-standard partitioning.	6NPV-2 Recognise the place value of each digit in numbers up to 10 million, including decimal fractions, and compose and decompose numbers up to 10 million using standard and non-standard partitioning.
	1NPV-2 Reason about the location of numbers to 20 within the linear number system, including comparing using < > and =	2NPV-2 Reason about the location of any two-digit number in the linear number system, including identifying the previous and next multiple of 10.	3NPV-3 Reason about the location of any <i>three</i> -digit number in the linear number system, including identifying the previous and next multiple of 100 and 10.	4NPV-3 Reason about the location of any <i>four</i> -digit number in the linear number system, including identifying the previous and next multiple of 1,000 and 100, and rounding to the nearest of each.	5NPV-3 Reason about the location of any number with up to 2 decimals places in the linear number system, including identifying the previous and next multiple of 1 and 0.1 and rounding to the nearest of each.	6NPV-3 Reason about the location of any number up to 10 million, including decimal fractions, in the linear number system, and round numbers, as appropriate, including in contexts.

Strand	Year 1	Year 2	Year 3	Year 4	Year 5	Year 6
NPV			3NPV-4 Divide 100 into 2, 4, 5 and 10 equal parts, and read scales/number lines marked in multiples of 100 with 2, 4, 5 and 10 equal parts. →	4NPV-4 Divide 1,000 into 2, 4, 5 and 10 equal parts, and read scales/number lines marked in multiples of 1,000 with 2, 4, 5 and 10 equal parts. →	5NPV-4 Divide 1 into 2, 4, 5 and 10 equal parts, and read scales/number lines marked in units of 1 with 2, 4, 5 and 10 equal parts. →	6NPV-4 Divide powers of 10, from 1 hundredth to 10 million, into 2, 4, 5 and 10 equal parts, and read scales/number lines with labelled intervals divided into 2, 4, 5 and 10 equal parts.
					5NPV-5 Convert between units of measure, including using common decimals and fractions.	
NF	1NF-1 Develop fluency in addition and subtraction facts within 10. →	2NF-1 Secure fluency in addition and subtraction facts within 10, through continued practice. →	3NF-1 Secure fluency in addition and subtraction facts that bridge 10, through continued practice.			
	1NF-2 Count forwards and backwards in multiples of 2, 5 and 10, up to 10 multiples, beginning with any multiple, and count forwards and backwards through the odd numbers. →		3NF-2 Recall multiplication facts, and corresponding division facts, in the 10, 5, 2, 4 and 8 multiplication tables, and recognise products in these multiplication tables as multiples of the corresponding number. →	4NF-1 Recall multiplication and division facts up to 12×12 , and recognise products in multiplication tables as multiples of the corresponding number. →	5NF-1 Secure fluency in multiplication table facts, and corresponding division facts, through continued practice.	
				4NF-2 Solve division problems, with two-digit dividends and one-digit divisors, that involve remainders, and interpret remainders appropriately according to the context.		
			3NF-3 Apply place-value knowledge to known additive and multiplicative number facts (scaling facts by 10). →	4NF-3 Apply place-value knowledge to known additive and multiplicative number facts (scaling facts by 100) →	5NF-2 Apply place-value knowledge to known additive and multiplicative number facts (scaling facts by 1 tenth or 1 hundredth).	

Strand	Year 1	Year 2	Year 3	Year 4	Year 5	Year 6
AS	1AS-1 Compose numbers to 10 from 2 parts, and partition numbers to 10 into parts, including recognising odd and even numbers.	2AS-1 Add and subtract across 10.	3AS-1 Calculate complements to 100.			6AS/MD-1 Understand that 2 numbers can be related additively or multiplicatively, and quantify additive and multiplicative relationships (multiplicative relationships restricted to multiplication by a whole number).
	1AS-2 Read, write and interpret equations containing addition (+), subtraction (-) and equals (=) symbols, and relate additive expressions and equations to real-life contexts.	2AS-2 Recognise the subtraction structure of 'difference' and answer questions of the form, "How many more...?".	3AS-2 Add and subtract up to three-digit numbers using columnar methods.			6AS/MD-2 Use a given additive or multiplicative calculation to derive or complete a related calculation, using arithmetic properties, inverse relationships, and place-value understanding.
		2AS-3 Add and subtract within 100 by applying related one-digit addition and subtraction facts: add and subtract only ones or only tens to/from a two-digit number.	3AS-3 Manipulate the additive relationship: Understand the inverse relationship between addition and subtraction, and how both relate to the part-part-whole structure. Understand and use the commutative property of addition, and understand the related property for subtraction.			6AS/MD-3 Solve problems involving ratio relationships.
		2AS-4 Add and subtract within 100 by applying related one-digit addition and subtraction facts: add and subtract any 2 two-digit numbers.				6AS/MD-4 Solve problems with 2 unknowns.

Strand	Year 1	Year 2	Year 3	Year 4	Year 5	Year 6
MD		2MD–1 Recognise repeated addition contexts, representing them with multiplication equations and calculating the product, within the 2, 5 and 10 multiplication tables.	3MD–1 Apply known multiplication and division facts to solve contextual problems with different structures, including quotitive and partitive division.	4MD–1 Multiply and divide whole numbers by 10 and 100 (keeping to whole number quotients); understand this as equivalent to making a number 10 or 100 times the size. →	5MD–1 Multiply and divide numbers by 10 and 100; understand this as equivalent to making a number 10 or 100 times the size, or 1 tenth or 1 hundredth times the size.	For year 6, MD ready-to-progress criteria are combined with AS ready-to-progress criteria (please see above).
		2MD–2 Relate grouping problems where the number of groups is unknown to multiplication equations with a missing factor, and to division equations (quotitive division).		4MD–2 Manipulate multiplication and division equations, and understand and apply the commutative property of multiplication.	5MD–2 Find factors and multiples of positive whole numbers, including common factors and common multiples, and express a given number as a product of 2 or 3 factors.	
				4MD–3 Understand and apply the distributive property of multiplication. →	5MD–3 Multiply any whole number with up to 4 digits by any one-digit number using a formal written method.	
					5MD–4 Divide a number with up to 4 digits by a one-digit number using a formal written method, and interpret remainders appropriately for the context.	

Strand	Year 1	Year 2	Year 3	Year 4	Year 5	Year 6
F			3F-1 Interpret and write proper fractions to represent 1 or several parts of a whole that is divided into equal parts.			6F-1 Recognise when fractions can be simplified, and use common factors to simplify fractions.
			3F-2 Find unit fractions of quantities using known division facts (multiplication tables fluency). →		5F-1 Find non-unit fractions of quantities.	6F-2 Express fractions in a common denomination and use this to compare fractions that are similar in value.
			3F-3 Reason about the location of any fraction within 1 in the linear number system. →	4F-1 Reason about the location of mixed numbers in the linear number system.		6F-3 Compare fractions with different denominators, including fractions greater than 1, using reasoning, and choose between reasoning and common denomination as a comparison strategy.
				4F-2 Convert mixed numbers to improper fractions and vice versa.	5F-2 Find equivalent fractions and understand that they have the same value and the same position in the linear number system.	
			3F-4 Add and subtract fractions with the same denominator, within 1. →	4F-3 Add and subtract improper and mixed fractions with the same denominator, including bridging whole numbers.	5F-3 Recall decimal fraction equivalents for $\frac{1}{2}$, $\frac{1}{4}$, $\frac{1}{5}$ and $\frac{1}{10}$, and for multiples of these proper fractions.	
G	1G-1 Recognise common 2D and 3D shapes presented in different orientations, and know that rectangles, triangles, cuboids and pyramids are not always similar to one another. →	2G-1 Use precise language to describe the properties of 2D and 3D shapes, and compare shapes by reasoning about similarities and differences in properties. →	3G-1 Recognise right angles as a property of shape or a description of a turn, and identify right angles in 2D shapes presented in different orientations.		5G-1 Compare angles, estimate and measure angles in degrees (°) and draw angles of a given size.	

Strand	Year 1	Year 2	Year 3	Year 4	Year 5	Year 6
G					5G–2 Compare areas and calculate the area of rectangles (including squares) using standard units.	
	1G–2 Compose 2D and 3D shapes from smaller shapes to match an example, including manipulating shapes to place them in particular orientations. →		3G–2 Draw polygons by joining marked points, and identify parallel and perpendicular sides. →	4G–1 Draw polygons, specified by coordinates in the first quadrant, and translate within the first quadrant. →		6G–1 Draw, compose, and decompose shapes according to given properties, including dimensions, angles and area, and solve related problems.
				4G–2 Identify regular polygons, including equilateral triangles and squares, as those in which the side-lengths are equal and the angles are equal. Find the perimeter of regular and irregular polygons.		
				4G–3 Identify line symmetry in 2D shapes presented in different orientations. Reflect shapes in a line of symmetry and complete a symmetric figure or pattern with respect to a specified line of symmetry.		

Year 5 guidance

Ready-to-progress criteria

Year 4 conceptual prerequisite	Year 5 ready-to-progress criteria	Future applications
Know that 10 hundreds are equivalent to 1 thousand, and that 1,000 is 10 times the size of 100; apply this to identify and work out how many 100s there are in other four-digit multiples of 100.	<p>5NPV–1 Know that 10 tenths are equivalent to 1 one, and that 1 is 10 times the size of 0.1.</p> <p>Know that 100 hundredths are equivalent to 1 one, and that 1 is 100 times the size of 0.01.</p> <p>Know that 10 hundredths are equivalent to 1 tenth, and that 0.1 is 10 times the size of 0.01.</p>	<p>Solve multiplication problems that have the scaling structure, such as ‘ten times as long’.</p> <p>Understand that per cent relates to ‘number of parts per hundred’, and write percentages as a fraction with denominator 100, and as a decimal fraction.</p>
Recognise the place value of each digit in four-digit numbers, and compose and decompose four-digit numbers using standard and non-standard partitioning.	<p>5NPV–2 Recognise the place value of each digit in numbers with up to 2 decimal places, and compose and decompose numbers with up to 2 decimal places using standard and non-standard partitioning.</p>	<p>Compare and order numbers, including those with up to 2 decimal places.</p> <p>Add and subtract using mental and formal written methods.</p>
Reason about the location of any four-digit number in the linear number system, including identifying the previous and next multiple of 1,000 and 100, and rounding to the nearest of each.	<p>5NPV–3 Reason about the location of any number with up to 2 decimals places in the linear number system, including identifying the previous and next multiple of 1 and 0.1 and rounding to the nearest of each.</p>	<p>Compare and order numbers, including those with up to 2 decimal places.</p> <p>Estimate and approximate to the nearest 1 or 0.1.</p>
Divide 1,000 into 2, 4, 5 and 10 equal parts, and read scales/number lines marked in multiples of 1,000 with 2, 4, 5 and 10 equal parts.	<p>5NPV–4 Divide 1 into 2, 4, 5 and 10 equal parts, and read scales/number lines marked in units of 1 with 2, 4, 5 and 10 equal parts.</p>	<p>Read scales on graphs and measuring instruments.</p>

Year 4 conceptual prerequisite	Year 5 ready-to-progress criteria	Future applications
<p>Divide 100 and 1,000 into 2, 4, 5 and 10 equal parts.</p> <p>Find unit fractions of quantities using known division facts (multiplication tables fluency).</p>	<p>5NPV-5 Convert between units of measure, including using common decimals and fractions.</p>	<p>Read scales on measuring instruments, and on graphs related to measures contexts.</p> <p>Solve measures problems involving different units by converting to a common unit.</p>
<p>Recall multiplication and division facts up to 12×12.</p> <p>Solve division problems, with two-digit dividends and one-digit divisors, that involve remainders, for example: $74 \div 9 = 8 \text{ r } 2$</p>	<p>5NF-1 Secure fluency in multiplication table facts, and corresponding division facts, through continued practice.</p>	<p>Use multiplication facts during application of formal written layout.</p> <p>Use division facts during short division and long division.</p>
<p>Apply place-value knowledge to known additive and multiplicative number facts (scaling facts by 10 or 100), for example:</p> <p>$8 + 6 = 14$ $80 + 60 = 140$ $800 + 600 = 1,400$</p> <p>$3 \times 4 = 12$ $30 \times 4 = 120$ $300 \times 4 = 1,200$</p>	<p>5NF-2 Apply place-value knowledge to known additive and multiplicative number facts (scaling facts by 1 tenth or 1 hundredth), for example:</p> <p>$8 + 6 = 14$ $0.8 + 0.6 = 1.4$ $0.08 + 0.06 = 0.14$</p> <p>$3 \times 4 = 12$ $0.3 \times 4 = 1.2$ $0.03 \times 4 = 0.12$</p>	<p>Recognise number relationships within the context of place value to develop fluency and efficiency in calculation.</p>
<p>Multiply and divide whole numbers by 10 and 100 (keeping to whole number quotients); understand this as equivalent to scaling a number by 10 or 100.</p>	<p>5MD-1 Multiply and divide numbers by 10 and 100; understand this as equivalent to making a number 10 or 100 times the size, or 1 tenth or 1 hundredth times the size.</p>	<p>Convert between different metric units of measure.</p>

Year 4 conceptual prerequisite	Year 5 ready-to-progress criteria	Future applications
<p>Recall multiplication and division facts up to 12×12, and recognise products in multiplication tables as multiples of the corresponding number.</p> <p>Recognise multiples of 10, 100 and 1,000.</p> <p>Apply place-value knowledge to known additive and multiplicative number facts.</p> <p>Multiply and divide whole numbers by 10 and 100 (keeping to whole number quotients).</p>	<p>5MD-2 Find factors and multiples of positive whole numbers, including common factors and common multiples, and express a given number as a product of 2 or 3 factors.</p>	<p>Solve contextual division problems.</p> <p>Simplify fractions.</p> <p>Express fractions in the same denomination.</p>
<p>Recall multiplication facts up to 12×12.</p> <p>Manipulate multiplication and division equations.</p>	<p>5MD-3 Multiply any whole number with up to 4 digits by any one-digit number using a formal written method.</p>	<p>Solve contextual and non-contextual multiplication problems using a formal written method.</p>
<p>Recall multiplication and division facts up to 12×12.</p> <p>Manipulate multiplication and division equations.</p> <p>Solve division problems, with two-digit dividends and one-digit divisors, that involve remainders, for example:</p> <p>$74 \div 9 = 8 \text{ r } 2$</p> <p>and interpret remainders appropriately according to the context.</p>	<p>5MD-4 Divide a number with up to 4 digits by a one-digit number using a formal written method, and interpret remainders appropriately for the context.</p>	<p>Solve contextual and non-contextual division problems using a formal written method.</p>
<p>Recall multiplication and division facts up to 12×12.</p> <p>Find unit fractions of quantities using known division facts (multiplication-tables fluency).</p> <p>Unitise using unit fractions (for example, understand that there are 3 one-fifths in three-fifths).</p>	<p>5F-1 Find non-unit fractions of quantities.</p>	<p>Solve multiplication problems that have the scaling structure.</p>

Year 4 conceptual prerequisite	Year 5 ready-to-progress criteria	Future applications
<p>Recall multiplication and division facts up to 12×12.</p> <p>Reason about the location of fractions in the linear number system.</p>	<p>5F-2 Find equivalent fractions and understand that they have the same value and the same position in the linear number system.</p>	<p>Compare and order fractions.</p> <p>Use common factors to simplify fractions.</p> <p>Use common multiples to express fractions in the same denomination.</p> <p>Add and subtract fractions with different denominators and mixed numbers, using the concept of equivalent fractions.</p>
<p>Divide powers of 10 into 2, 4, 5 and 10 equal parts.</p>	<p>5F-3 Recall decimal fraction equivalents for $\frac{1}{2}$, $\frac{1}{4}$, $\frac{1}{5}$ and $\frac{1}{10}$, and for multiples of these proper fractions.</p>	<p>Read scales on graphs and measuring instruments.</p> <p>Know percentage equivalents of common fractions.</p>
<p>Recognise right angles as a property of shape or a description of a turn, and identify right angles in 2D shapes presented in different orientations.</p> <p>Identify whether the interior angles of a polygon are equal or not.</p>	<p>5G-1 Compare angles, estimate and measure angles in degrees ($^{\circ}$) and draw angles of a given size.</p>	<p>Solve problems involving missing angles.</p>
<p>Compose polygons from smaller shapes.</p> <p>Recall multiplication facts up to 12×12.</p>	<p>5G-2 Compare areas and calculate the area of rectangles (including squares) using standard units.</p>	<p>Calculate the area of compound rectilinear shapes and other 2D shapes, including triangles and parallelograms, using standard units.</p> <p>Use the relationship between side-length and perimeter, and between side-length and area to calculate unknown values.</p>

5NPV–1 Tenths and hundredths

Know that 10 tenths are equivalent to 1 one, and that 1 is 10 times the size of 0.1.
Know that 100 hundredths are equivalent to 1 one, and that 1 is 100 times the size of 0.01.

Know that 10 hundredths are equivalent to 1 tenth, and that 0.1 is 10 times the size of 0.01.

5NPV–1 Teaching guidance

This criterion follows on from what pupils learnt in years 3 and 4 about the relationship between adjacent place-value positions. The value of a given digit is made 10 times the size if it is moved 1 position to left, and is made one tenth times the size if it is moved 1 position to the right. Pupils should learn, therefore, that we can extend the place-value chart to include positions to the right of the ones place.

1,000s	100s	10s	1s	0.1s	0.01s
1					
	1				
		1			
			1		
				1	
					1

Figure 1: place-value chart illustrating the scaling relationship between adjacent positions, including tenths and hundredths

Pupils should understand that:

- a '1' in the tenths column has a value of one tenth, and is one tenth the size of 1
- a '1' in the hundredths column has a value of one hundredth, and is one hundredth the size of 1

Pupils should learn that the decimal point is used between the ones digit and the tenths digit, so that we can write decimal numbers without using a place-value chart. They should learn that one tenth is written as 0.1 and one hundredth is written as 0.01.

Pupils must be able to describe the relationships between 1, 0.1 and 0.01.

Language focus

“1 is 10 times the size of one-tenth.”

“One-tenth is 10 times the size of one-hundredth.”

“1 is 100 times the size of one-hundredth.”

As well as understanding one-tenth and one-hundredth as scaling 1, pupils must understand them in terms of regrouping and exchanging. Dienes can be used to illustrate the relative size of 1, one-tenth and one-hundredth, with a ‘flat’ now representing 1. Pupils should experience how 10 hundredths can be regrouped into one-tenth, and how both 10 tenths and 100 hundredths can be regrouped into 1 one. Conversely they should be able to exchange 1 one for 10 tenths or for 100 hundredths and 1 tenth for 10 hundredths.

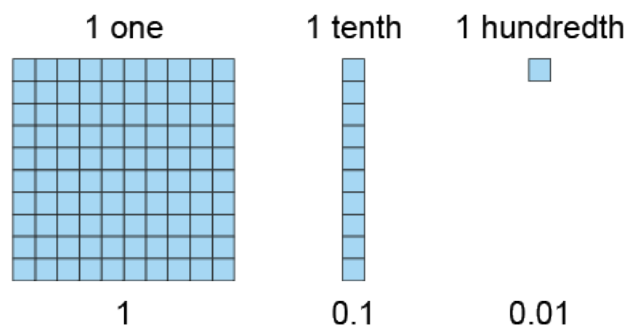

Figure 2: using Dienes to represent 1, one-tenth and one-hundredth

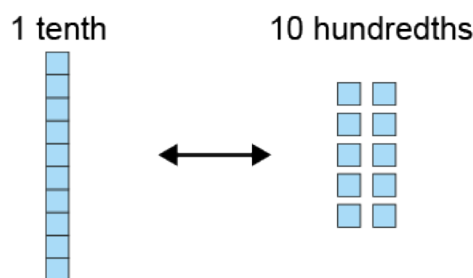

Figure 3: using Dienes to represent the equivalence of 1 tenth and 10 hundredths

Pupils must describe the equivalence between the different quantities using unitising language (unitising in ones, tenths and hundredths).

Language focus

“10 tenths is equal to 1 one.”

“10 hundredths is equal to 1 tenth.”

“100 hundredths is equal to 1 one.”

Once pupils understand the relative size of these new units, they should learn to use place-value counters to represent the equivalence. Pupils must then be able to work out how many tenths there are in other multiples of 0.1 and how many hundredths there are in other multiples of 0.01. Initially pupils should work with values that involve only the tenths place (for example 0.4) or only the hundredths place (for example 0.04). Once they have learnt to write numbers with tenths and hundredths ([5NPV-2](#)), they should be able to reason, for example, that:

- 18 hundredths is equal to 1 tenth and 8 hundredths, and is written as 0.18
- 18 tenths is equal to 1 one and 8 tenths, and is written as 1.8



Figure 4: eighteen 0.01-value place-value counters in 2 tens frames

Language focus

“18 hundredths is equal to 10 hundredths and 8 more hundredths.”

“10 hundredths is equal to 1 tenth.”

“So 18 hundredths is equal to 1 tenth and 8 more hundredths, which is 0.18.”

Pupils need to be able to apply this reasoning to measures contexts, as shown in the Example assessment questions below.

This learning should also be connected to pupils' understanding of fractions – they should understand that one-tenth can be written as both 0.1 and $\frac{1}{10}$ and that one hundredth can be written as both 0.01 and $\frac{1}{100}$. Pupils should be able to write, for example, 18 hundredths as both 0.18 and $\frac{18}{100}$.

Making connections

Pupils need to be able to write numbers in decimal notation (**5NPV-2**) to be able to make the connection between, for example 18 tenths and 1.8. Meeting **5NPV-1** also supports **5NF-2** (applying place value to known number facts) because, if pupils can unitise in tenths and hundredths, and, for example understand that 12 tenths = 1.2 and 12 hundredths = 0.12, then they can reason that:

- $0.5 + 0.7 = 1.2$ (5 tenths plus 7 tenths is equal to 12 tenths, which is 1.2)
- $0.03 \times 4 = 0.12$ (3 hundredths times 4 is equal to 12 hundredths, which is 0.12)

5NPV-1 Example assessment questions

1. An apple weighs about 0.1kg. Approximately how many apples are there in a 1.8kg bag?
2. I have a 0.35m length of wooden rod. How many 0.01m lengths can I cut it into?
3. Mrs Jasper is juicing oranges. Each orange makes about 0.1 litres of juice. If Mrs Jasper juices 22 oranges, approximately how many litres of orange juice will she get?
4. Circle all of the numbers that are equal to a whole number of tenths.

0.2 4.8 1 0.01 10 0.83

5. Fill in the missing numbers.

$$0.01 \times \boxed{} = 1 \qquad 0.1 \times \boxed{} = 1 \qquad 0.01 \times \boxed{} = 0.1$$

6. Fill in the missing numbers.

$$\boxed{} \text{ tenths} = 3.9$$

$$\boxed{} \text{ hundredths} = 0.22$$

$$\boxed{} \text{ hundredths} = 8$$

7. Match the numbers on the left with the equivalent fractions on the right.

0.20	$\frac{2}{100}$
0.02	$\frac{21}{100}$
0.12	$\frac{2}{10}$
0.21	$\frac{12}{100}$

5NPV–2 Place value in decimal fractions

Recognise the place value of each digit in numbers with up to 2 decimal places, and compose and decompose numbers with up to 2 decimal places using standard and non-standard partitioning.

5NPV–2 Teaching guidance

Pupils must be able to read, write and interpret decimal fractions with up to 2 decimal places. Pupils should work first with decimal fractions with one significant digit (for example, 0.3 and 0.03). The Gattegno chart is a useful tool here.

1,000	2,000	3,000	4,000	5,000	6,000	7,000	8,000	9,000
100	200	300	400	500	600	700	800	900
10	20	30	40	50	60	70	80	90
1	2	3	4	5	6	7	8	9
0.1	0.2	0.3	0.4	0.5	0.6	0.7	0.8	0.9
0.01	0.02	0.03	0.04	0.05	0.06	0.07	0.08	0.09

Figure 5: Gattegno chart showing thousands, hundreds, tens, ones, tenths and hundredths

The number 300 is spoken as “three hundred” rather than as “three-zero-zero”, and this helps pupils to identify the value of the 3 in 300. However, decimal fractions are usually spoken as digits, for example, 0.03 is spoken as “zero-point-zero-three” (or “nought-point-nought-three”) rather than “three hundredths”. As such, pupils need to practise speaking decimal fractions in both ways and learn to convert from one to the other.

Language focus

“Three hundredths is zero-point-zero-three.”

Pupils must then learn to work with decimal fractions with 2 significant digits (for example, 0.36). For any given decimal fraction of this type, pupils must be able to connect the spoken words (zero-point-three-six), the value in decimal notation (0.36), describing the number of tenths and hundredths (3 tenths and 6 hundredths) and visual representations (such as place-value counters and the Gattegno chart).

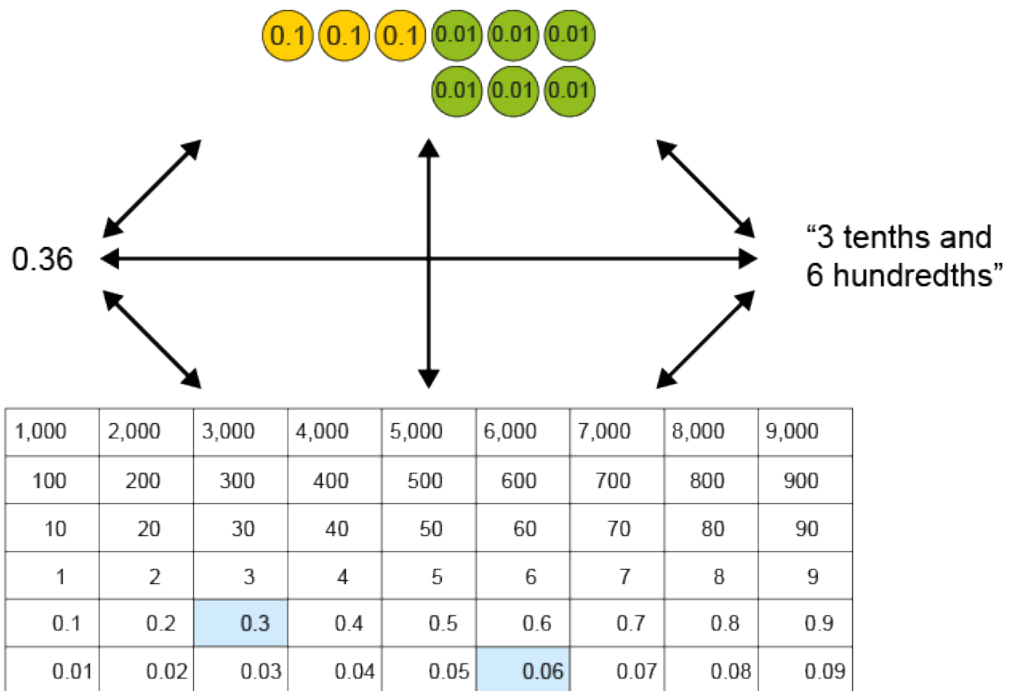

Figure 6: 4 different representations of 0.36

Pupils should be able to identify the place value of each digit in numbers with up to 2 decimal places. They must be able to combine units of hundredths, tenths, ones, tens, hundreds and thousands to compose numbers, and partition numbers into these units. Pupils need to experience variation in the order of presentation of the units, so that they understand that $0.4 + 3 + 0.02 + 50$ is equal to 53.42, not 43.25.

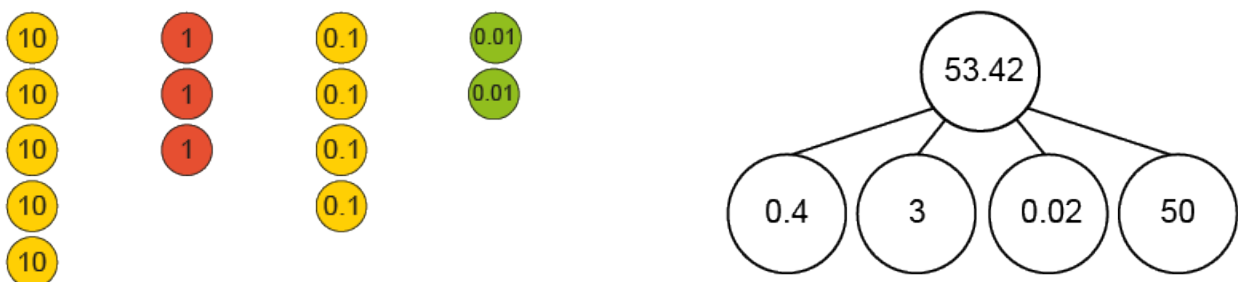

Figure 7: 2 representations of the place-value composition of 53.42

Pupils also need to solve problems relating to subtraction of any single place-value part from the whole number, for example:

$$53.42 - 3 = \square$$

$$53.42 - \square = 53.02$$

As well as being able to partition numbers in the 'standard' way (into individual place-value units), pupils must also be able to partition numbers in 'non-standard' ways and carry out related addition and subtraction calculations, for example:

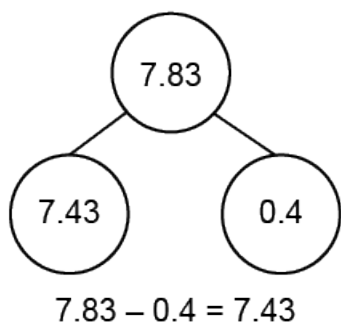

Figure 8: partitioning 7.83 into 7.43 and 0.4

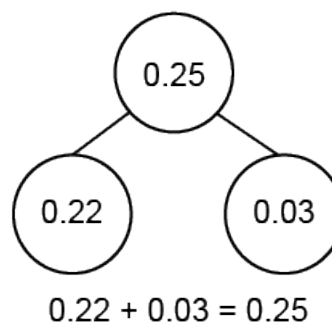

Figure 9: partitioning 0.25 into 0.22 and 0.03

You can find out more about fluency and recording for these calculations here in the calculation and fluency section: [Number, place value and number facts: 5NPV-2 and 5NF-2](#)

5NPV-2 Example assessment questions

1. Complete the calculations.

$$4 + 0.07 + 0.2 = \square$$

$$0.4 + 0.02 + 70 = \square$$

$$20 + 0.07 + 4 = \square$$

$$0.4 + 20 + 700 = \square$$

2. Circle the numbers that add together to give a total of 0.14

0.04

0.12

0.1

0.2

3. Fill in the missing numbers.

$3.87 - 0.8 = \square$

$25.14 - 0.04 = \square$

$19.7 - 9 = \square$

$99.99 - 90 = \square$

$84.51 = 50 + \square$

$0.3 + 5.61 = \square$

$95.75 - 0.5 = \square$

$6.14 = 5 + \square + 0.04$

$2 + 1.43 + 0.05 = \square$

- I have 3.7kg of modelling clay. If we use 2kg, how much will be left?
- I will use 0.65 litres of milk for one recipe, and 0.23 litres of milk for another. How much milk will I use altogether?
- Ilaria jumped 3.19m in a long jump competition. Emma jumped 3.12m. How much further did Ilaria jump than Emma?
- Maya cycled 7.3km to get to her friend's house, and then cycled a further 0.6km to the park. How far did Maya cycle altogether?

5NPV-3 Decimal fractions in the linear number system

Reason about the location of any number with up to 2 decimal places in the linear number system, including identifying the previous and next multiple of 1 and 0.1 and rounding to the nearest of each.

5NPV-3 Teaching guidance

Pupils need to become familiar with the relative positions, on a number line, of numbers with 1 and 2 decimal places. They will need to see number lines with both tenths and intermediate hundredths values marked, and learn, for example, that 0.5 is the same as 0.50 and 3 is the same as 3.0 or 3.00. Pupils should recognise the magnitude and position of a given decimal fraction, irrespective of the precision it is given to, for example, 5 tenths lies between 0.45 and 0.55 on the number line below, whether it is represented as 0.5 or 0.50.

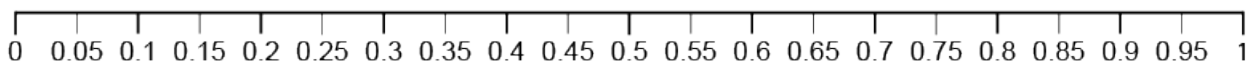

Figure 10: 0 to 1 number line marked and labelled in intervals of 5 hundredths

Pupils need to be able to identify or place decimal fractions on number lines marked in tenths and/or hundredths. They should use efficient strategies and appropriate reasoning, including identifying the midpoints or working backwards from a whole number or a multiple of one tenth.

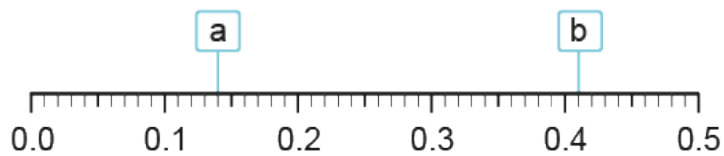

Figure 11: identifying 0.14 and 0.41 on a 0 to 0.5 number line marked with intervals of hundredths

Language focus

“a is 0.14 because it is 1 hundredth less than the midpoint of 0.1 and 0.2, which is 0.15.”

“b is 0.41 because it is 1 hundredth more than 0.4.”

Pupils need to be able to estimate the value or position of decimal fractions on unmarked or partially marked numbers lines, using appropriate proportional reasoning, rather than counting on from a start point or back from an end point. For example, here pupils should reason: “8.6 is about *here* on the number line because it’s just over half way”.



Figure 12: placing 8.6 on an unmarked 8 to 9 number line

Here, pupils should reason: “8.75 is about *here* on the number line because it’s the midpoint of 8.7 and 8.8.”

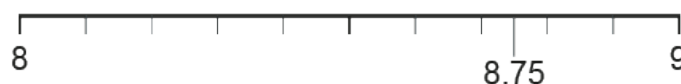

Figure 13: placing 8.75 on an 8 to 9 number line marked only in tenths

Pupils must also be able to identify which whole numbers, or which pair of multiples of 0.1, a given decimal fraction is between. To begin with, pupils can use a number line for support. In this example, for the number 8.61, pupils must identify the previous and next whole number, and the previous and next multiple of 0.1.

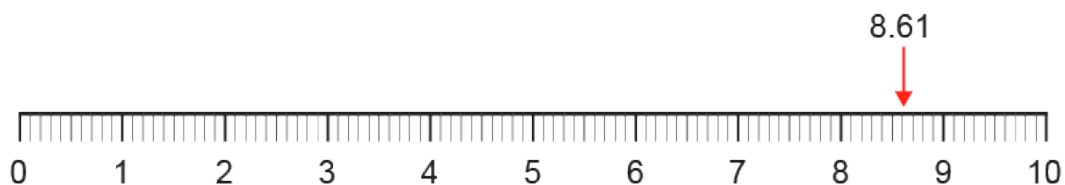

Figure 14: using a number line to identify the previous and next whole number

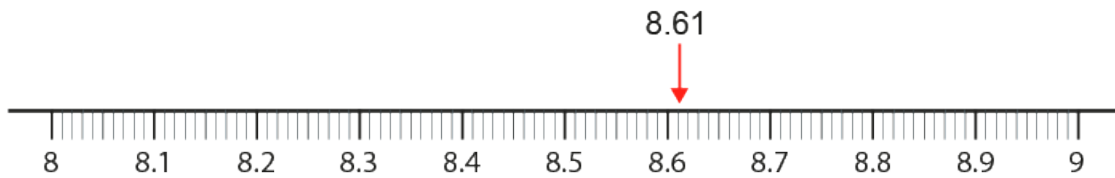

Figure 15: using a number line to identify the previous and next multiple of 0.1

Language focus

“The previous whole number is 8. The next whole number is 9.”

“The previous multiple of 0.1 is 8.6. The next multiple of 0.1 is 8.7.”

By the end of year 5 pupils need to be able to complete this type of task without the support of a number line.

Pupils should then learn to round a given decimal fraction to the nearest whole number by identifying the nearest of the pair of whole numbers that the decimal fraction is between. Similarly, pupils should learn to round to the nearest multiple of 0.1. They should understand that they need to examine the digit in the place to the right of the unit they are rounding to, for example when rounding to the nearest whole number, pupils must examine the digit in the tenths place. Again, pupils can initially use number lines for support, but should be able to round without that support by the end of year 5.



Figure 16: identifying the nearest whole number with a number line for support

Language focus

“The closest whole number is 9.”

“8.61 rounded to the nearest whole number is 9.”

Finally, pupils should also be able to count forwards and backwards from any decimal fraction in steps of 1, 0.1 or 0.01. Pay particular attention to counting over ‘boundaries’, for example:

- 2.1, 2.0, 1.9
- 2.85, 2.95, 3.05

Making connections

Here, pupils must apply their knowledge that 10 tenths is equal to 1 one (see [5NPV-1](#)) to understand that each interval of 1 on a number line or scale is made up of 10 intervals of 0.1. Similarly, they must use their knowledge that 10 hundredths is equal to 1 tenth to understand that each interval of 0.1 on a number line or scale is made up of 10 intervals of 0.01. This also links to [5NPV-4](#), in which pupils need to be able to read scales divided into 2, 4, 5 and 10 equal parts.

5NPV-3 Example assessment questions

1. Place each of these numbers on the number line.

0.6 0.16 0.91 0.09 0.69

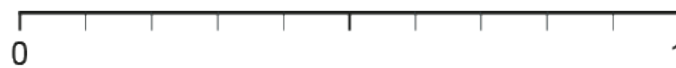

2. The table shows how far some children jumped in a long-jump competition.

Name	Distance jumped (m)
Jamal	3.04
Reyna	3.4
Faisal	2.85
Ilaria	3.19
Charlie	3.09
Kagendo	2.9

- a. Who jumped the furthest and won the competition?
- b. Who came third in the competition?
- c. How much further did Kagendo jump than Faisal?

d. How much further did Ilaria jump than Charlie?

3. Fill in the missing symbols (<, > or =).

$0.3 \square 0.5$

$0.03 \square 0.05$

$0.50 \square 0.5$

$9 \square 9.00$

$0.2 \square 0.15$

$0.11 \square 0.09$

$1.01 \square 1.1$

$3 \square 2.99$

$140 \square 1.40$

4. Here is a weighing scale. Estimate the mass in kilograms that the arrow is pointing to.

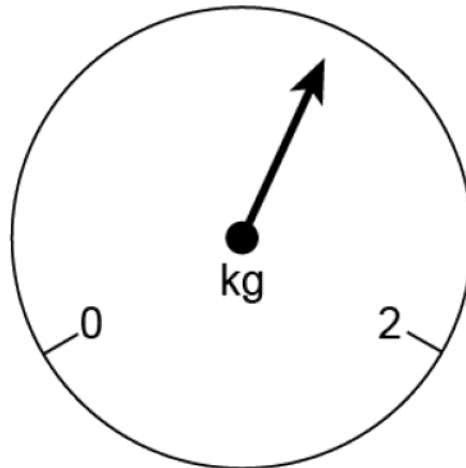

5. Estimate and mark the position of 0.7 litres on this beaker.

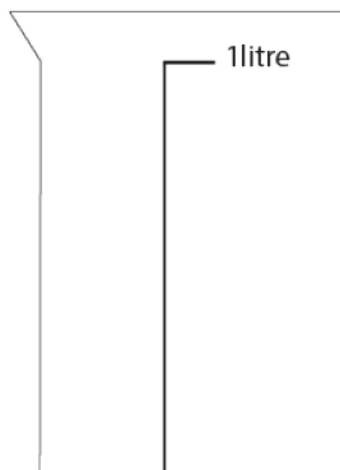

6. Fill in the missing numbers.

			5.01	5.02	5.03	
--	--	--	------	------	------	--

3.65			3.95			4.25	4.35
------	--	--	------	--	--	------	------

			27.9	27.8	27.7
--	--	--	------	------	------

7. A farmer weighed each of 6 new-born lambs. Round the mass of each lamb to the nearest whole kilogram.

	Rounded to nearest whole kilogram
5.19kg	
6.7kg	
4.08kg	
6.1kg	
6.45kg	
4.91kg	

8. I need 4.25 metres of ribbon.

- How much is this to the nearest tenth of a metre?
- How much is this to the nearest metre?
- If ribbon is sold only in whole metres, how many metres do I need to buy?

5NPV–4 Reading scales with 2, 4, 5 or 10 intervals

Divide 1 into 2, 4, 5 and 10 equal parts, and read scales/number lines marked in units of 1 with 2, 4, 5 and 10 equal parts.

5NPV–4 Teaching guidance

By the end of year 5, pupils must be able to divide 1 into 2, 4, 5 or 10 equal parts. This is important because these are the intervals commonly found on measuring instruments and graph scales.

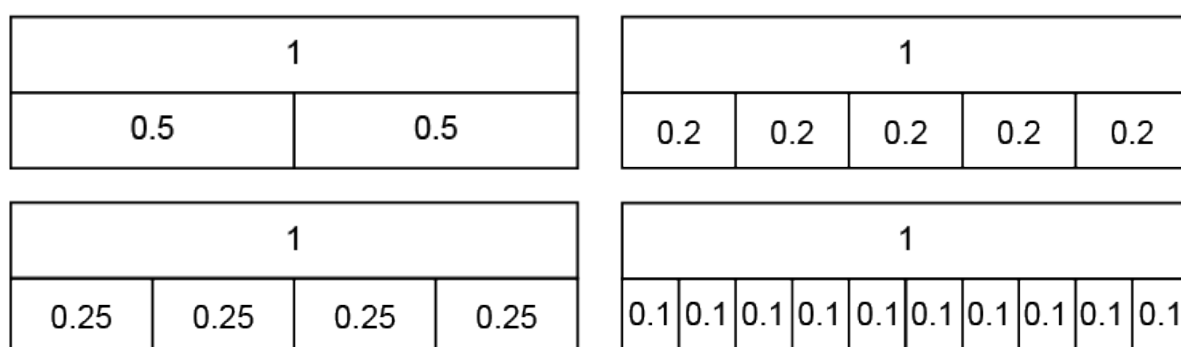

Figure 17: bar models showing 1 partitioned into 2, 4, 5 and 10 equal parts

Pupils should practise counting in multiples of 0.1, 0.2, 0.25 and 0.5 from 0, or from any multiple of these numbers, both forwards and backwards. This is an important step in becoming fluent with these number patterns.

Language focus

“Twenty-five, fifty, seventy-five, one hundred” needs to be a fluent spoken language pattern. Fluency in this language pattern provides the basis to count in multiples of 0.25.

Pupils should be able to apply this skip counting, beyond 1, to solve contextual multiplication and division measures problems, as shown in [5NPV–4 Example assessment questions](#) below (questions 8 to 10). Pupils should also be able to write, solve and manipulate multiplication and division equations related to multiples of 0.1, 0.2, 0.25 and 0.5 up to 1, and connect this to their knowledge of fractions, and decimal-fraction equivalents ([5F–3](#)).

Pupils need to be able to solve addition and subtraction problems based on partitioning 1 into multiples of 0.1, 0.2 and 0.5 based on known number bonds to 10. Pupils should also have automatic recall of the fact that 0.25 and 0.75 are bonds to 1. They should be able to immediately answer a question such as “I have 1 litre of water and pour out 0.25 litres. How much is left?”

Making connections

Dividing 1 into 10 equal parts is also assessed as part of [5NPV-1](#).

Reading scales also builds on number-line knowledge from [5NPV-3](#). Conversely, experience of working with scales with 2, 4, 5 or 10 divisions in this criterion improves pupils’ estimating skills when working with unmarked number lines and scales as described in [5NPV-3](#).

In [5F-3](#) pupils need to be fluent in common fraction–decimal equivalents, for example, $\frac{3}{4} = 0.75$. This criterion provides the foundations for [5F-3](#).

5NPV-4 Example assessment questions

1. Fill in the missing parts, and write as many different equations as you can think of to represent the bar model.

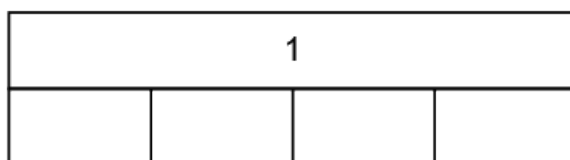

2. Fill in the missing numbers.

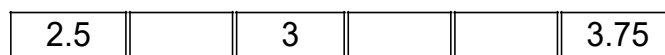
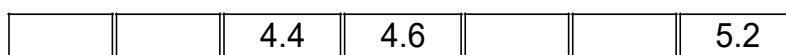
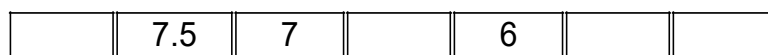

3. 5 children have been growing sunflowers. The bar chart shows how tall each child's sunflower has grown. How tall is each flower?

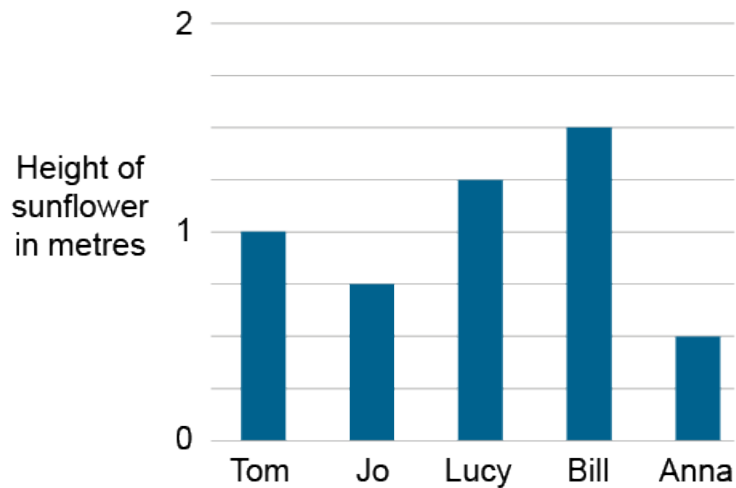

4. The bar chart below shows long-jump distances for 6 children.

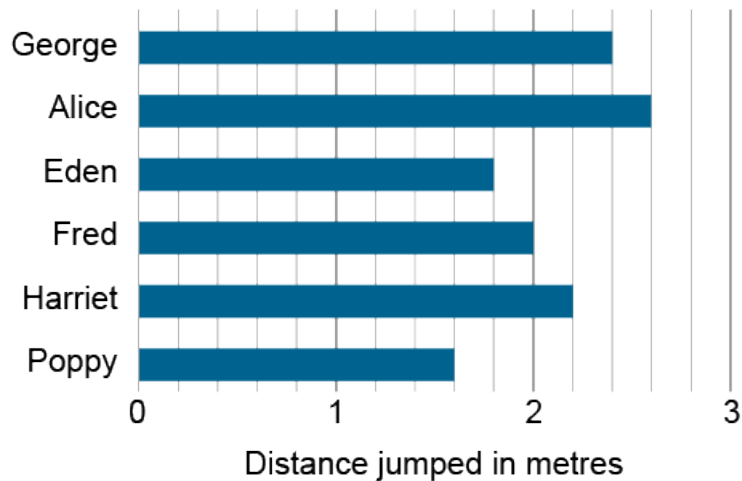

- a. How far did the winning child jump?
 b. What was the difference between the two longest jumps?
5. Complete the labelling of these scales.

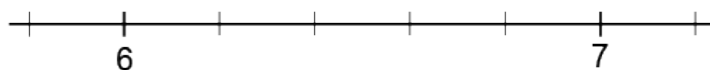
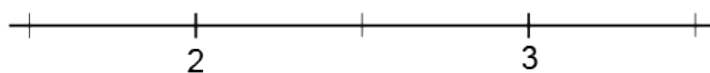
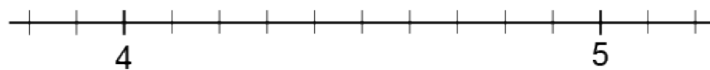
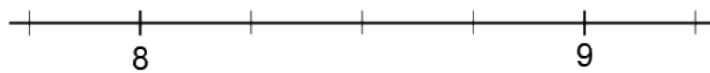

6. What is the reading on each of these scales, in kilograms?

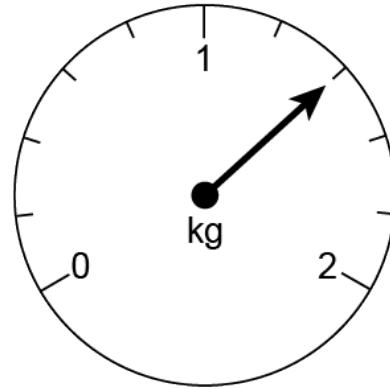
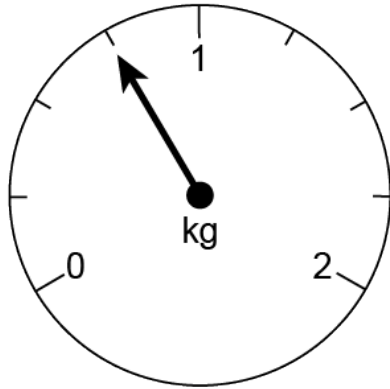

7. Here is a 1 litre beaker with some liquid in. How much more liquid, in litres, do I need to add to the beaker to make 1 litre?

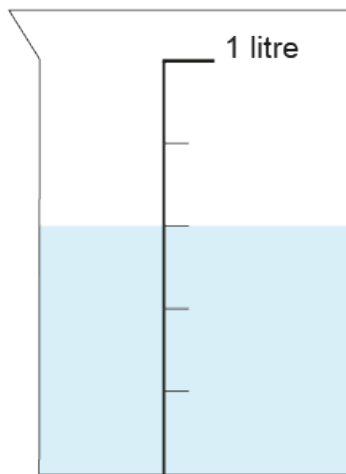

8. A motorway repair team can build 0.2km of motorway barrier in 1 day. In 6 working days, how many kilometres of motorway barrier can they build?

9. How many 0.25 litre servings of orange juice are there in a 2 litre carton?

10. 0.25m of ribbon costs £1. How much does 2m of ribbon cost?

11. Fill in the missing numbers.

$$1 - 0.2 = \square$$

$$5 \times \square \text{ m} = 1 \text{ m}$$

$$1 \div 5 = \square$$

$$1 - 0.8 = \square$$

$$4 \times \square \text{ m} = 1 \text{ m}$$

$$1 \div 5 = 1 - \square$$

$$1 - \square = 1 - 0.2 - 0.2$$

$$5 \times 0.2 \text{ m} = 4 \times \square \text{ m}$$

12. Here is a part of a number line divided into 4 equal parts.

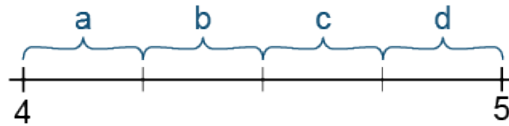

In which section (a, b, c or d) does each of these numbers belong? Explain your answers.

4.3 4.03 4.09 4.76 4.41 4.69

5NPV–5 Convert between units of measure

Convert between units of measure, including using common decimals and fractions.

5NPV–5 Teaching guidance

Pupils should first memorise the following unit conversions:

1km = 1,000m

1m = 100cm

1cm = 10mm

1 litre = 1,000ml

1kg = 1,000g

£1 = 100p

It is essential that enough time is given to this foundational stage before moving on. Practical experience of these conversions will help pupils to avoid common errors in recalling the correct power of 10 for a given conversion. For example, they can walk 1km while counting the number of metres using a trundle measuring wheel.

Once pupils can confidently recall these conversions, they should apply them to whole number conversions, from larger to smaller units and vice versa, for example, £4 = 400p and 8,000g = 8kg. Pupils must then learn to convert from and to fraction and decimal-fraction quantities of larger units, within 1, for example 0.25km = 250m. They should be able to carry out conversions that correspond to some of the common 2, 4, 5 and 10 part measures intervals, as exemplified below for kilometre–metre conversions.

Distance in km expressed as a fraction	Distance in km expressed as a decimal fraction	Distance in metres
$\frac{1}{5}$ km	0.2km	200m
$\frac{1}{4}$ km	0.25km	250m
$\frac{1}{2}$ km	0.5km	500m
$\frac{3}{4}$ km	0.75m	750m
$\frac{1}{10}$ km	0.1km	100m
all other multiples of $\frac{1}{10}$ km, for example, $\frac{7}{10}$ km	0.7km	700m

For finding $\frac{3}{4}$ of a unit, pupils should have sufficient fluency in the association between $\frac{3}{4}$ and 0.75, 75 and 750 that they should not need to first work out $\frac{1}{4}$ and multiply by 3.

For all conversions, pupils should begin by stating the single unit conversion rate as a step to the fraction or decimal-fraction conversion.

Language focus

“1m is 100cm.”

“So is 75cm.”

Pupils should learn to derive other common conversions over 1. To convert, for example, 3,700 millilitres to litres, they should not need to think about dividing by 1,000 and moving the digits 3 places. Instead they should be able to use single unit conversion rates and their understanding of place value.

Language focus

“1,000ml is 1 litre.”

“So 3,000ml is 3 litres, and 3,700ml is 3.7 litres.”

For pounds and pence, and metres and centimetres, pupils should also be able to carry out conversions that correspond to 100 parts, for example, 52p = £0.52, and 43cm = 0.43m.

Language focus

“100p is £1.”

“So 50p is £0.50, and 52p is £0.52.”

Pupils can use ratio tables for support.

1m	100cm	1,000ml	1 litre	100p	£1
$\frac{3}{4}$ m	75cm	3,700ml	3.7 litres	52p	£0.52

Pupils must learn to solve measures problems involving different units by converting to a common unit.

Making connections

To succeed with this criterion, pupils must be fluent in the division of 1,000, 100 and 1 into 2, 4, 5 and 10 equal parts (**4NPV-4** , **3NPV-4** and **5NPV-4** respectively). They must also be able to recall common fraction-decimal equivalents (**5F-3**). The fraction conversions in this criterion are special cases of finding fractions of quantities (**5F-1**).

5NPV-5 Example assessment questions

1. Fill in the missing numbers to complete these conversions between units.

$1.8 \text{ litres} = \boxed{} \text{ ml}$

$\frac{3}{4} \text{ km} = \boxed{} \text{ m}$

$5\frac{1}{2} \text{ cm} = \boxed{} \text{ mm}$

$£8.12 = \boxed{} \text{ p}$

$4\frac{1}{4} \text{ kg} = \boxed{} \text{ g}$

$3.4 \text{ m} = \boxed{} \text{ cm}$

$21 \text{ mm} = \boxed{} \text{ cm}$

$2,250 \text{ ml} = \boxed{} \text{ litres}$

$650 \text{ cm} = \boxed{} \text{ m}$

$8,300 \text{ m} = \boxed{} \text{ km}$

$165 \text{ p} = £ \boxed{}$

$750 \text{ g} = \boxed{} \text{ kg}$

2. Put these volumes in order from smallest to largest.

0.75 litres

1.1 litres

0.3 litres

$\frac{1}{5}$ litre

900ml

$1\frac{1}{2}$ litres

3. Put these lengths in order from smallest to largest.

0.45m

10mm

208cm

$2\frac{1}{2}$ m

80cm

0.9m

$\frac{1}{2}$ cm

4. Maya needs to post 3 parcels. The mass of each parcel is shown below. How much do the parcels weigh altogether, in kilograms?

Parcel	Mass of parcel
A	3.2kg
B	4,500g
C	$1\frac{1}{2}$ kg

5. Finn has a $7\frac{1}{2}$ m length of wood. How many $\frac{3}{4}$ m length pieces can he cut from it?

6. I need $1\frac{1}{4}$ kg of flour for a recipe. I pour some flour into the weighing scales.
How much more flour do I need for the recipe?

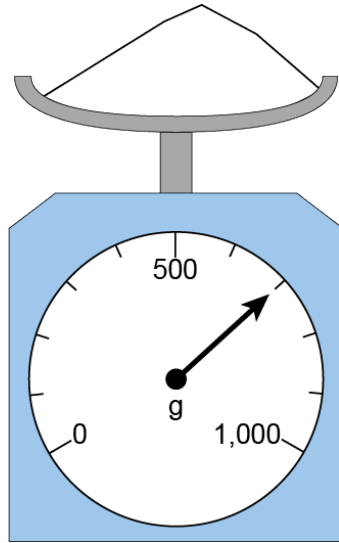

7. Fill in the values in the empty circles so that each row and column of 3 circles adds to 5km.

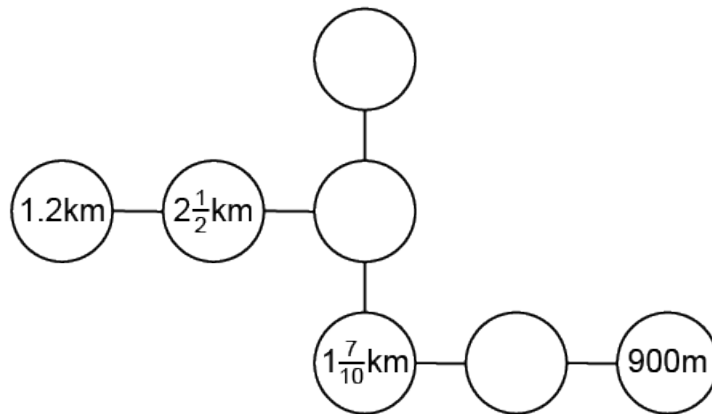

5NF–1 Secure fluency in multiplication and division facts

Secure fluency in multiplication table facts, and corresponding division facts, through continued practice.

5NF–1 Teaching guidance

Before pupils begin work on formal multiplication and division ([5MD–3](#) and [5MD–4](#)), it is essential that pupils have automatic recall of multiplication and division facts within the multiplication tables. These facts are required for calculation within the ‘columns’ during application of formal written methods. All mental multiplicative calculation also depends on these facts.

Identifying core number facts: short multiplication	Identifying core number facts: short division
$\begin{array}{r} 342 \\ \times \quad 7 \\ \hline 2,394 \\ \underline{21} \end{array}$ <p>Figure 18: short multiplication of 342 by 7</p>	$\begin{array}{r} 619 \\ 8 \overline{)4,952} \end{array}$ <p>Figure 19: short division of 4,952 by 8</p>
<p>Within-column calculations:</p> $7 \times 2 = 14$ $7 \times 4 + 1 = 28 + 1$ $7 \times 3 + 2 = 21 + 2$	<p>Within-column calculations:</p> $4 \div 8 = 0 \text{ r } 4$ $49 \div 8 = 6 \text{ r } 1$ $15 \div 8 = 1 \text{ r } 7$ $72 \div 8 = 9$

Pupils should already have automatic recall of multiplication table facts and corresponding division facts, from year 3 (5, 10, 2, 4 and 8 multiplication tables, [3NF–2](#)) and year 4 (all multiplication tables up to and including 12, [4NF–1](#)). Pupils’ fluency in multiplication facts is assessed in the summer term of year 4 in the statutory multiplication tables check, and this will identify some pupils who need additional practice. However, even pupils who were fluent in the multiplication tables at the time of the multiplication tables check will benefit from further practice to maintain and secure fluency. Pupils must also be able to fluently derive related division facts, including division facts with remainders before they begin to learn formal written methods for multiplication and division ([5MD–3](#) and [5MD–4](#)).

The multiplication facts to 9×9 , and related division facts, are particularly important as these are the facts required for formal written multiplication and division. The 36 multiplication facts that are required for formal written multiplication are as follows.

$2 \times 2 = 4$								
$3 \times 2 = 6$	$3 \times 3 = 9$							
$4 \times 2 = 8$	$4 \times 3 = 12$	$4 \times 4 = 16$						
$5 \times 2 = 10$	$5 \times 3 = 15$	$5 \times 4 = 20$	$5 \times 5 = 25$					
$6 \times 2 = 12$	$6 \times 3 = 18$	$6 \times 4 = 24$	$6 \times 5 = 30$	$6 \times 6 = 36$				
$7 \times 2 = 14$	$7 \times 3 = 21$	$7 \times 4 = 28$	$7 \times 5 = 35$	$7 \times 6 = 42$	$7 \times 7 = 49$			
$8 \times 2 = 16$	$8 \times 3 = 24$	$8 \times 4 = 32$	$8 \times 5 = 40$	$8 \times 6 = 48$	$8 \times 7 = 56$	$8 \times 8 = 64$		
$9 \times 2 = 18$	$9 \times 3 = 27$	$9 \times 4 = 36$	$9 \times 5 = 45$	$9 \times 6 = 54$	$9 \times 7 = 63$	$9 \times 8 = 72$	$9 \times 9 = 81$	

You can find out more about multiplicative fluency here in the calculation and fluency section: [5NF-1](#)

Making connections

Fluency in these multiplicative facts is required for:

- mental calculation, when combined with place-value knowledge, for example, if pupils know that $3 \times 4 = 12$, then they can calculate $0.3 \times 4 = 1.2$ and $0.03 \times 4 = 0.12$ ([5NF-2](#))
- identifying factors and multiples ([5MD-1](#))
- within-column calculation in short multiplication ([5MD-3](#)) and short division ([5MD-4](#))
- calculating fractions of quantities ([5F-1](#))
- finding equivalent fractions ([5F-2](#))
- calculating area ([5G-2](#))

5NF-1 Assessment guidance

Assessment for this criterion should focus on whether pupils have fluency in multiplication facts and division facts. Pupils can be assessed through a time-limited written check.

5NF–2 Scaling number facts by 0.1 or 0.01

Apply place-value knowledge to known additive and multiplicative number facts (scaling facts by 1 tenth or 1 hundredth), for example:

$$8 + 6 = 14$$

$$0.8 + 0.6 = 1.4$$

$$0.08 + 0.06 = 0.14$$

$$3 \times 4 = 12$$

$$0.3 \times 4 = 1.2$$

$$0.03 \times 4 = 0.12$$

5NF–2 Teaching guidance

Pupils must be able to combine known additive and multiplicative facts with unitising in tenths and hundredths, including:

- scaling known additive facts within 10, for example, $0.09 - 0.06 = 0.03$
- scaling known additive facts that bridge 10, for example, $0.8 + 0.6 = 1.4$
- scaling known multiplication tables facts, for example $0.03 \times 4 = 0.12$
- scaling division facts derived from multiplication tables, for example, $0.12 \div 4 = 0.03$
- scaling calculation of complements to 100, for example $0.62 + 0.38 = 1$

For calculations such as $0.8 + 0.6 = 1.4$, pupils can begin by using tens frames and counters as they did for calculation across 10 ([2AS–1](#)), calculation across 100 ([3NF–3](#)) and calculation across 1,000 ([4NF–3](#)), but now using 0.1-value counters (or 0.01 value counters for calculations such as $0.08 + 0.06 = 0.14$).

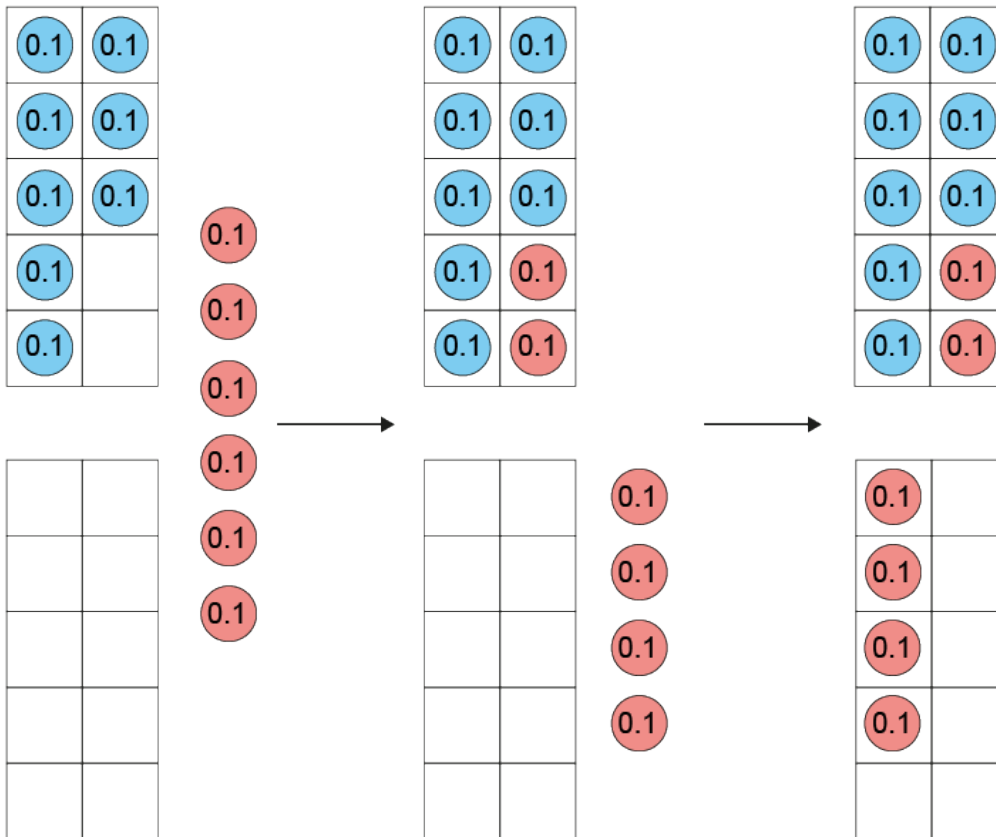

Figure 20: tens frames with 0.1-value counters showing $0.8 + 0.6 = 1.4$

$$8 + 6 = 14$$

$$0.8 + 0.6 = 1.4$$

$$14 - 6 = 8$$

$$1.4 - 0.6 = 0.8$$

$$14 - 8 = 6$$

$$1.4 - 0.8 = 0.6$$

Language focus

“8 plus 6 is equal to 14, so 8 tenths plus 6 tenths is equal to 14 tenths.”

“14 tenths is equal to 1 one and 4 tenths.”

Pupils must also be able to scale additive calculations related to complements to 100 (**3AS-1**), for example:

$$62 + 38 = \boxed{100}$$

so

$$0.62 + 0.38 = \boxed{1}$$

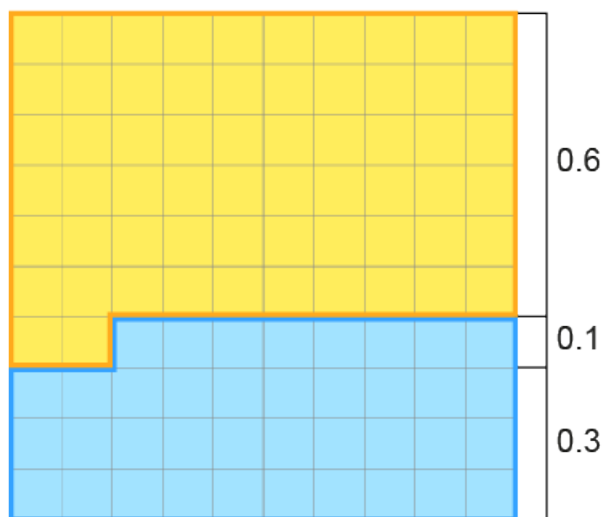

Figure 21: a 100 grid shaded in 2 colours to represent 0.62 and 0.38 as a complement to 1

Pupils can initially use 0.1- or 0.01-value counters to understand how a known multiplicative fact, such as $3 \times 5 = 15$, relates to scaled calculations, such as $3 \times 0.5 = 1.5$ or $3 \times 0.05 = 0.15$. Pupils should be able to reason in terms of unitising in tenths or hundreds, or in terms of scaling a factor by one-tenth or one-hundredth.



Figure 22: 3-by-5 array of 0.01-value place-value counters

$$3 \times 5 = 15$$

$$3 \times 0.05 = 0.15$$

$$3 \times 5 = 15$$

$$0.03 \times 5 = 0.15$$

Language focus

“3 times 5 is equal to 15.”

“3 times 5 hundredths is equal to 15 hundredths.”

“15 hundredths is equal to 0.15.”

Language focus

“3 times 5 is equal to 15.”

“3 hundredths times 5 is equal to 15 hundredths.”

“15 hundredths is equal to 0.15.”

Language focus

“If I make one factor one-hundredth times the size, I must make the product one-hundredth times the size.”

Pupils must be able to make similar connections for known division facts, for example, for scaling by one-hundredth:

$$15 \div 3 = 5$$

$$0.15 \div 0.03 = 5$$

$$0.15 \div 3 = 0.05$$

Language focus

“If I make the dividend one-hundredth times the size and the divisor one-hundredth times the size, the quotient remains the same.”

“If I make the dividend one-hundredth times the size and keep the divisor the same, I must make the quotient one-hundredth times the size.”

It is important for pupils to understand all of the calculations in this criterion in terms of working with units of 0.1 or 0.01, or scaling by one-tenth or one-hundredth for multiplicative calculations.

You can find out more about fluency and recording for these calculations here in the calculation and fluency section: [Number, place value and number facts: 5NPV-2 and 5NF-2](#)

Making connections

This criterion builds on:

- known addition and subtraction facts
- [5NF-1](#), where pupils secure fluency in multiplication and division facts
- [5NPV-1](#), where pupils need to be able to work out how many tenths or hundredths there are in given numbers

Meeting this criterion also requires pupils to be able to fluently divide whole numbers by 10 or 100 ([5MD-1](#)).

5NF–2 Example assessment questions

1. Circle the numbers that sum to 0.13

0.1 0.5 0.05 0.8 0.08 0.3

2. Are these calculations correct? Mark each correct calculation with a tick (✓) and each incorrect calculation with a cross (✗). Explain your answers.

$$0.05 + 0.05 = 0.010$$

$$0.04 + 0.06 = 0.1$$

$$0.13 + 0.7 = 0.2$$

$$0.61 + 0.49 = 1$$

$$0.73 + 0.27 = 1$$

$$0.4 + 0.5 = 0.45$$

3. I live 0.4km away from school. Every day I walk to school in the morning and home again in the afternoon.
- How far do I walk each day?
 - How far do I walk in 5 days?
4. Some children are making bunting for the school fair. If each child makes 0.4m of bunting, and there are 12 children, how many metres of bunting do they make altogether?
5. A chef needs 2.4kg of potatoes for a recipe. If one potato weighs about 0.3kg, approximately how many potatoes does the chef need?
6. A bottle contains 0.7 litres of fruit drink. Maria need 5 litres of drink for a party. How many bottles does she need to buy?
7. I need 0.5kg of brown flour and 0.7kg of white flour for a recipe. What is the total mass of flour that I need?
8. What is the total volume of liquid in these measuring beakers, in litres?

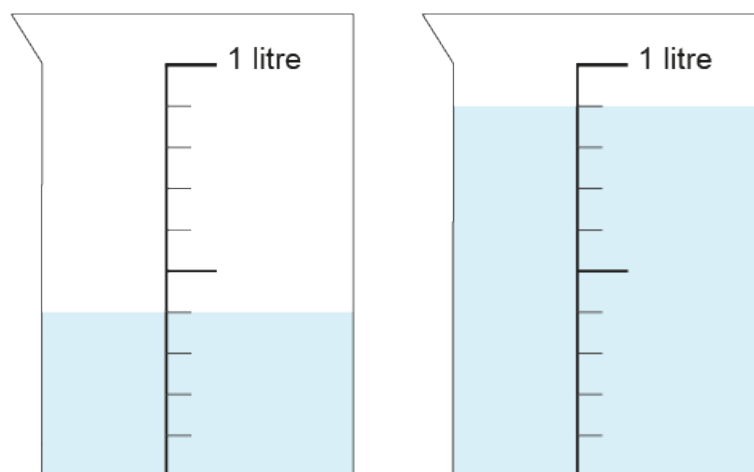

5MD–1 Multiplying and dividing by 10 and 100

Multiply and divide numbers by 10 and 100; understand this as equivalent to making a number 10 or 100 times the size, or 1 tenth or 1 hundredth times the size.

5MD–1 Teaching guidance

In years 3 and 4, pupils considered multiplication and division by 10 and 100 both in terms of scaling (for example, 2,300 is 100 times the size of 23) and in terms of grouping or unitising (for example, 2,300 is 23 groups of 100). To meet criterion **5MD–1**, pupils should be able to use and understand the language of 10 or 100 times the size to describe multiplication of numbers, including decimal fractions, by 10 or 100. They should understand division as the inverse action, and should be able to use and understand the language of one-tenth or one-hundredth times the size to describe division of numbers by 10 or 100, including to calculations that give decimal fraction quotients.

Pupils already know the following relationships between powers of ten, and can describe them using scaling language (“...times the size”).

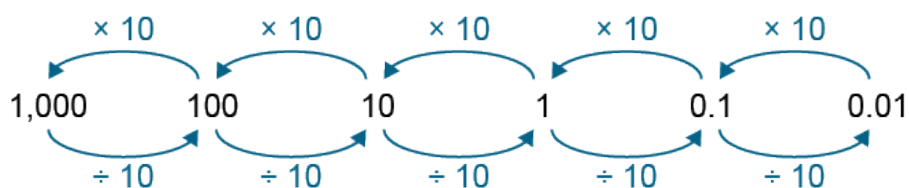

Figure 23: multiplicative relationships between powers of 10: 10 times the size and one-tenth times the size

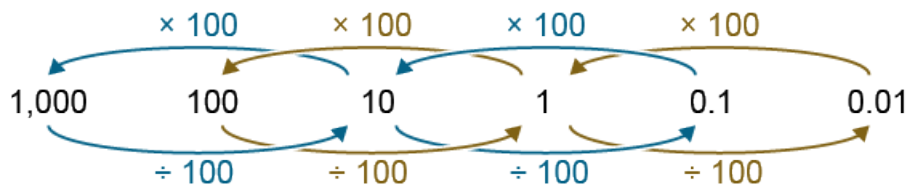

Figure 24: multiplicative relationships between powers of 10: 100 times the size and one-hundredth times the size

Pupils should extend the ‘ten times the size’/‘one-tenth times the size’ relationship to multiplicative calculations that ‘cross’ 1, beginning with those with 1 significant figure. The Gattegno chart can be used to help pupils see, for example, that 8, made one-tenth times the size is 0.8; pupils can move their finger or a counter *down* from 8 to 0.8. Pupils must connect this action to division by 10, and be able to solve/write the corresponding division calculation ($8 \div 10 = 0.8$). Similarly, because 8 is 10 times the size of 0.8, they can solve 0.8×10 , moving their finger or a counter *up* from 0.8 to 8.

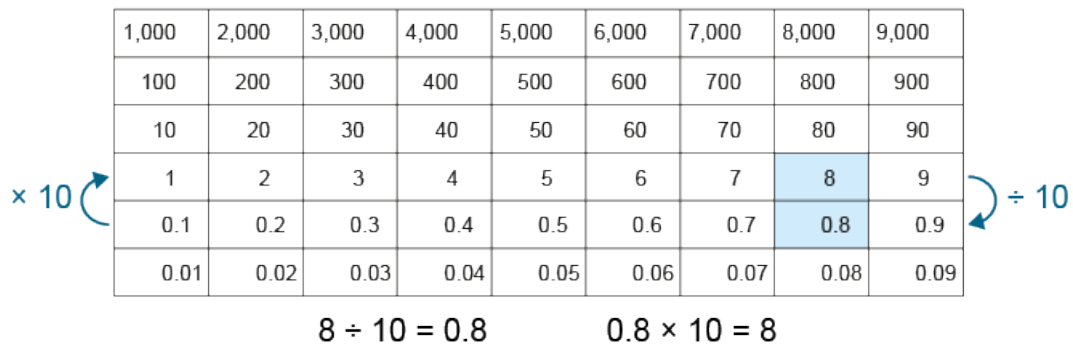

Figure 25: using the Gattegno chart to multiply and divide by 10, crossing 1

Language focus

“8, made one-tenth of the size, is 0.8.”

“8 divided by 10 is equal to 0.8.”

“First we had 8 ones. Now we have 8 tenths.”

“0.8, made 10 times the size, is 8.”

“0.8 multiplied by 10 is equal to 8.”

“First we had 8 tenths. Now we have 8 ones.”

Pupils may also work with place-value charts.

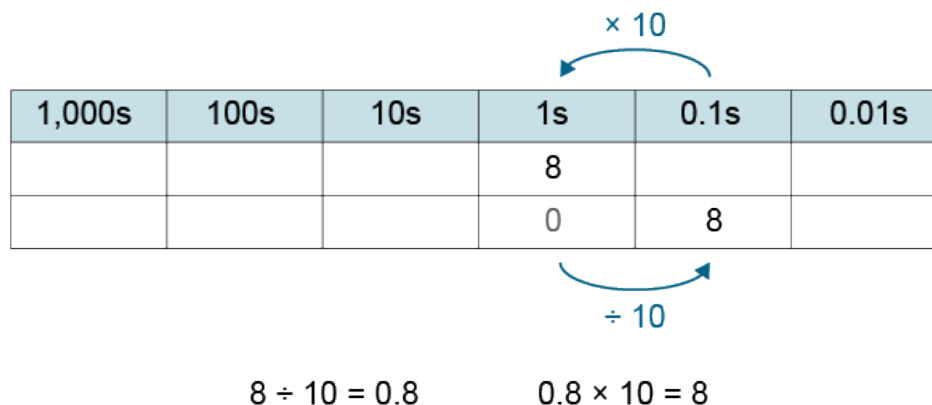

Figure 26: using a place-value chart to multiply and divide by 10, crossing 1

Similarly, pupils should be able to:

- divide ones by 100 and carry out inverse multiplications, for example, $8 \div 100 = 0.08$ and $0.08 \times 100 = 8$
- divide tenths by 10 and carry out inverse multiplications, for example, $0.8 \div 10 = 0.08$ and $0.08 \times 10 = 0.8$

This understanding should then be extended to multiplicative calculations that ‘cross’ 1 and involve numbers with *more* than one significant digit, for example:

$$13 \div 100 = 0.13$$

$$0.13 \times 100 = 13$$

$$26.5 \div 10 = 2.65$$

$$2.65 \times 10 = 26.5$$

$$4,710 \div 100 = 47.1$$

$$47.1 \times 100 = 4,710$$

Throughout this criterion, repeated association of the written form (for example, $\div 10$) and the verbal form (for example, “one tenth times the size”) will help pupils become fluent with the links. Pupils should also be able to use appropriate language to describe the relationships in different contexts, including measures.

Language focus

“8cm is 10 times the length of 0.8cm.”

“0.25kg is one-hundredth times the mass of 25kg.”

“150 pencils is 10 times as many as 15 pencils.”

Both the Gattegno chart and place-value charts can be used for support throughout this criterion, but by the end of year 5 pupils must be able to calculate without them. These representations can also help pupils to see that multiplying by 100 is equivalent to multiplying by 10, and then multiplying by 10 again (and that dividing by 100 is equivalent to dividing by 10 and dividing by 10 again).

Making connections

In [5NPV-1](#), pupils learnt to describe the relationship between different powers of 10 in terms of scaling. Here they applied this idea to scale other numbers by 100, 10, one-tenth and one-hundredth.

This criterion also supports scaling known additive and multiplicative number facts by 1 tenth or 1 hundredth. For example, the known fact $5 \times 3 = 15$ can be used to solve 5×0.3 : one factor (3) has been scaled by one tenth, so the product (15) must be scaled by one tenth.

5MD-1 Example assessment questions

1. Fill in the missing numbers.

$$\begin{array}{ccc}
 & \times 10 & \\
 & \rightarrow & \\
 \boxed{4.03} & & \boxed{} \\
 & \leftarrow & \\
 & \div 10 &
 \end{array}$$

$$\begin{array}{ccc}
 & \times 10 & \\
 & \rightarrow & \\
 \boxed{} & & \boxed{0.2} \\
 & \leftarrow & \\
 & \div 10 &
 \end{array}$$

$$\begin{array}{ccc}
 & \times 100 & \\
 & \rightarrow & \\
 \boxed{21.7} & & \boxed{} \\
 & \leftarrow & \\
 & \div 100 &
 \end{array}$$

$$\begin{array}{ccc}
 & \times 100 & \\
 & \rightarrow & \\
 \boxed{} & & \boxed{5,806} \\
 & \leftarrow & \\
 & \div 100 &
 \end{array}$$

- Ruby ran 2.3km. Her mum ran 10 times this distance. How far did Ruby's mum run?
- A zookeeper weighs an adult gorilla and its baby. The adult gorilla has a mass of 149.3kg. The baby gorilla has a mass one-tenth times that of the adult gorilla. How much does the baby gorilla weigh, in kilograms?

4. The length of a new-born crocodile is about 0.25m. The length of an adult female crocodile is about 2.5m. Approximately how many times as long as a new-born crocodile is an adult female crocodile?

5. Fill in the missing numbers.

$$\square \times 100 = 5$$

$$273 = \square \times 100$$

$$\square \times 10 = 6$$

$$42 = \square \times 10$$

$$\square \div 100 = 0.79$$

$$1.35 = \square \div 100$$

$$\square \div 10 = 0.75$$

$$16.2 = \square \div 10$$

6. Use the following to complete the equations:

$\times 10$

$\times 100$

$\div 10$

$\div 100$

Use each term only once.

$$543 \square = 5.43$$

$$0.12 \square = 1.2$$

$$51.5 \square = 5,150$$

$$40.3 \square = 4.03$$

5MD–2 Find factors and multiples

Find factors and multiples of positive whole numbers, including common factors and common multiples, and express a given number as a product of 2 or 3 factors.

5MD–2 Teaching guidance

Pupils should already know and be able to use the words ‘multiple’ and ‘factor’ in the context of the multiplication tables. They should know, for example, that the products within the 6 multiplication table are all multiples of 6, and should be familiar with the generalisation: $\text{factor} \times \text{factor} = \text{product}$

In year 5, pupils should learn the definitions of the terms ‘multiple’ and ‘factor’, and understand the inverse relationship between them.

Language focus

“A multiple of a given number is the product of the given number and any whole number.”

“A factor of a given number is a whole number that the given number can be divided by without giving a remainder.”

“21 is a multiple of 3. 3 is a factor of 21.”

Pupils must be able to identify factors and multiples within the multiplication tables, and should learn to work systematically to identify all of the factors of a given number. They should be able to express products in the multiplication tables as products of 3 factors, where relevant, for example, $48 = 2 \times 3 \times 8$.

Pupils already know how to scale known multiplication table facts by 10 or 100 (**3NF-3** and **4NF-3**), and must now learn to apply this to identify factors and multiples of larger numbers, as exemplified below.

$$7 \times 3 = 21$$

$$7 \times 300 = 2,100$$

$$700 \times 3 = 2,100$$

Language focus

“21 is a multiple of 3, so...

- 2,100 is a multiple of 300”
- 2,100 is a multiple of 3”

Pupils should learn to express multiples of 10 or 100 as products of 3 factors, for example:

$$7 \times 3 = 21$$

so

$$7 \times 3 \times 10 = 210$$

Pupils should learn that these factors can be written in any order (commutative property of multiplication) and that any pair of the factors can be multiplied together first (associative property of multiplication).

Applying commutativity		Applying associativity (example)
$3 \times 7 \times 10 = 210$	$3 \times 10 \times 7 = 210$	$3 \times 7 \times 10 = 210$

$7 \times 3 \times 10 = 210$	$7 \times 10 \times 3 = 210$	$(3 \times 7) \times 10 = 21 \times 10 = 210$
$10 \times 3 \times 7 = 210$	$10 \times 7 \times 3 = 210$	$3 \times (7 \times 10) = 3 \times 70 = 210$

Pupils should be able to recognise whether any given number is a multiple of 2, 5, or 10 by attending to the final digit and, conversely, recognise 2, 5, or 10 as factors.

Pupils should also be able to recognise multiples and factors linked to their experience of dividing powers of 10 into 2, 4 or 5 equal parts, by attending to the appropriate digit(s), for example:

- 175 is a multiple of 25 (attending to the final 2 digits) 25 is a factor of 175
- 8,500 is a multiple of 500 (attending to the final 3 digits) 500 is factor of 8,500
- 380 is a multiple of 20 (attending to the final 2 digits) 20 is a factor of 380

Pupils should learn to identify factors and multiples for situations other than those described above by using short division or divisibility rules. For example, to determine whether 392 is a multiple of 8 (or whether 8 is a factor of 392) pupils can use the divisibility rule for 8 or use short division to determine whether $392 \div 8$ results in a quotient without a remainder.

Pupils must learn how to find common factors and common multiples of small numbers in preparation for simplifying fractions and finding common denominators. They must also learn to recognise and use squared numbers and use the correct notation (for example, $3^2 = 9$), and learn to establish whether a given number (up to 100) is prime.

Making connections

Pupils must be fluent in their multiplication tables to meet this criterion ([5NF-1](#)), and must also be able to scale multiplication facts by 10 or 100.

Short division ([5MD-4](#)) can be used to identify factors when other strategies are not applicable.

5MD-2 Example assessment questions

1. Write all of the numbers from 1 to 30 in the correct places on this Venn diagram.

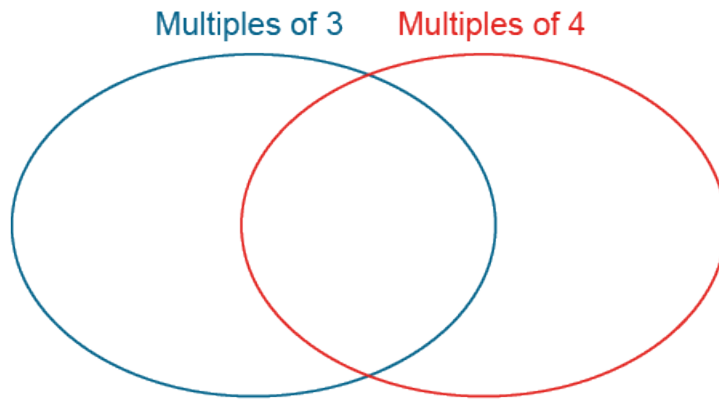

2. Circle any number that is a multiple of both 3 and 7.

42

43

47

49

3. Find a common factor of 48 and 64 that is greater than 6.

4. How many common multiples of 4 and 6 are there that are less than 40?

5. Circle any number that is a factor of both 24 and 36.

2

4

6

8

10

12

6. a. Find a multiple of 30 that is between 200 and 300.

b. Find a multiple of 40 that is between 300 and 400.

c. Find a multiple of 50 that is between 400 and 500.

7. Show that 3 is a factor of 231.

8. Fill in the table with examples of 2-, 3- and 4-digit numbers that are multiples of 9, 25 and 50.

	2-digit number	3-digit number	4-digit number
Multiples of 9			
Multiples of 25			
Multiples of 50			

9. Give two 2-digit factors of 270.

10. Find 3 numbers which are multiples of 25 but not multiples of 50.

11. Fill in the missing numbers.

$$6 \times 32 = 6 \times 4 \times \boxed{}$$

$$6 \times 5 \times 4 = 5 \times \boxed{}$$

$$480 = 8 \times 10 \times \boxed{}$$

$$72 = 2 \times 6 \times \boxed{}$$

$$\boxed{} \times 5 \times \boxed{} = 105$$

$$7 \times \boxed{} \times \boxed{} = 140$$

5MD–3 Multiply using a formal written method

Multiply any whole number with up to 4 digits by any one-digit number using a formal written method.

5MD–3 Teaching guidance

Pupils should learn to multiply multi-digit numbers by one-digit numbers using the formal written method of short multiplication. They should begin with examples that do not involve regrouping, such as the two-digit \times one-digit calculation shown below, and learn that, like columnar addition and subtraction, the algorithm begins with the least significant digit (on the right). When pupils first learn about short multiplication, place-value equipment (such as place-value counters) should be used to model the algorithm and help pupils relate it to what they already know about multiplication. Pupils should understand that short multiplication is based on the distributive property of multiplication which they learnt about in year 4 (**4MD–3**).

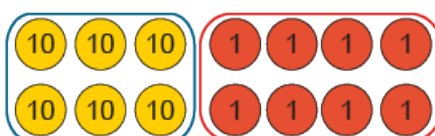

Figure 27: place-value counters showing 34×2

Informal written method	Expanded multiplication algorithm	Short multiplication																										
$34 \times 2 = 30 \times 2 + 4 \times 2$ $= 60 + 8$ $= 68$	<table style="border-collapse: collapse; margin-left: 20px;"> <tr> <td style="border-right: 1px solid black; padding: 5px;">10s</td> <td style="padding: 5px;">1s</td> <td></td> </tr> <tr> <td style="border-right: 1px solid black; padding: 5px;">3</td> <td style="padding: 5px;">4</td> <td></td> </tr> <tr> <td style="border-right: 1px solid black; padding: 5px;">x</td> <td style="padding: 5px;">2</td> <td></td> </tr> <tr> <td style="border-right: 1px solid black; padding: 5px;"></td> <td style="padding: 5px;">8</td> <td style="padding: 5px;">$2 \times 4 \text{ ones} = 8 \text{ ones}$</td> </tr> <tr> <td style="border-right: 1px solid black; padding: 5px;">6</td> <td style="padding: 5px;">0</td> <td style="padding: 5px;">$2 \times 3 \text{ tens} = 6 \text{ tens}$</td> </tr> <tr> <td style="border-right: 1px solid black; padding: 5px;">6</td> <td style="padding: 5px;">8</td> <td></td> </tr> </table>	10s	1s		3	4		x	2			8	$2 \times 4 \text{ ones} = 8 \text{ ones}$	6	0	$2 \times 3 \text{ tens} = 6 \text{ tens}$	6	8		<table style="border-collapse: collapse; margin-left: 20px;"> <tr> <td style="border-right: 1px solid black; padding: 5px;">10s</td> <td style="padding: 5px;">1s</td> </tr> <tr> <td style="border-right: 1px solid black; padding: 5px;">3</td> <td style="padding: 5px;">4</td> </tr> <tr> <td style="border-right: 1px solid black; padding: 5px;">x</td> <td style="padding: 5px;">2</td> </tr> <tr> <td style="border-right: 1px solid black; padding: 5px;">6</td> <td style="padding: 5px;">8</td> </tr> </table>	10s	1s	3	4	x	2	6	8
10s	1s																											
3	4																											
x	2																											
	8	$2 \times 4 \text{ ones} = 8 \text{ ones}$																										
6	0	$2 \times 3 \text{ tens} = 6 \text{ tens}$																										
6	8																											
10s	1s																											
3	4																											
x	2																											
6	8																											

Initially, pupils should use unitising language to help them understand and apply short multiplication.

Language focus

“2 times 4 ones is equal to 8 ones: write 8 in the ones column.”

“2 times 3 tens = 6 tens: write 6 in the tens column.”

Pupils may also use place-value headings while they learn to use the formal written method, as illustrated above. However, by the end of year 5, they must be able to use the short multiplication algorithm without using unitising language and place-value headings.

Once pupils have mastered the basic principles of short multiplication without regrouping, they must learn to use the algorithm where regrouping is required, for multiplication of numbers with up to 4 digits by one-digit numbers. Pupils can again use unitising language, now for support with regrouping, until they are able to apply the algorithm fluently.

$$\begin{array}{r} 367 \\ \times \quad 4 \\ \hline 1,468 \\ \underline{22} \end{array}$$

Figure 28: multiplying 367 by 4 using short multiplication

$$\begin{array}{l} 4 \times 7 \text{ ones} = 28 \text{ ones} \\ = 2 \text{ tens} + 8 \text{ ones} \\ 4 \times 6 \text{ tens} = 24 \text{ tens} \\ = 2 \text{ hundreds} + 4 \text{ tens} \\ \text{plus 2 more tens} = 2 \text{ hundreds} + 6 \text{ tens} \\ 4 \times 3 \text{ hundreds} = 12 \text{ hundreds} \\ = 1 \text{ thousand} + 2 \text{ hundreds} \\ \text{plus 2 more} \\ \text{hundreds} = 1 \text{ thousand} + 4 \text{ hundreds} \end{array}$$

Pupils must be able to use short multiplication to solve contextual multiplication problems with:

- the grouping structure (see [5MD–3 5MD-3](#), questions 3 to 6)
- the scaling structure (see **5MD–3 Example assessment questions**, questions 7 and 8)
- Pupils should also be able to use short multiplication to solve missing-dividend problems (for example, $? \div 2,854 = 3$)

Pupils must learn that, although short multiplication can be used to multiply any number by a one-digit number, it is not always the most appropriate choice. For example, 201×4 can be calculated mentally by applying the distributive property of multiplication ($200 \times 4 = 800$, plus 4 more).

You can find out more about recording and fluency for these calculations here in the calculation and fluency section: [5MD-3](#)

Making connections

Pupils must be fluent in multiplication facts within the multiplication tables ([5NF-1](#)) before they begin this criterion. Once pupils have learnt short division ([5MD-4](#)) they should be able to use short multiplication to check their short division calculations, and vice versa.

Pupils should be able to use short multiplication, where appropriate, when calculating a non-unit-fraction of a quantity ([5F-1](#)).

5MD-3 Example assessment questions

1. Fill in the missing numbers.

$$278 \times 6 = \square$$

$$\square = 7 \times 1,297$$

$$\square \div 2,854 = 3$$

$$\square \div 6 = 372$$

2. Draw a line to match each multiplication expression with the correct addition expression.

$$\boxed{48 \times 3}$$

$$\boxed{120 + 18}$$

$$\boxed{6 \times 23}$$

$$\boxed{80 + 4}$$

$$\boxed{26 \times 4}$$

$$\boxed{120 + 24}$$

3. Josh cycles 255 metres in 1 minute. If he keeps cycling at the same speed, how far will he cycle in 8 minutes?
4. A factory packs biscuits into boxes of 9. The factory produces 1,350 packets of biscuits in a day. How many biscuits is that?
5. Ellen has 1 large bag of 96 marbles, and 4 smaller bags each containing 76 marbles. How many marbles does she have altogether?
6. There are 6 eggs in a box. If a farmer needs to deliver 1,275 boxes of eggs to a supermarket, how many eggs does she need?
7. Aryan's grandmother lives 235 kilometres away from Aryan. His aunt lives 3 times that distance away from Aryan. How far away does Aryan's aunt live from him? How far is this to the nearest 100 kilometres?
8. Felicity can make 5 hairbands in 1 hour. A factory can make 235 times as many. How many hairbands can the factory make in 1 hour?
9. Fill in the missing numbers.

$$\begin{array}{r} \square 16 \\ \times \quad \square \\ \hline 2,864 \\ \hline 2 \end{array}$$

$$\begin{array}{r} \square 5 \square 7 \\ \times \quad 4 \\ \hline 6,108 \\ \hline 2 \ 1 \ 2 \end{array}$$

10. Liyana writes:

$$9,565 \div 7 = 1,365$$

Use short multiplication to check whether Liyana's equation is correct.

Assessment guidance: Pupils need to be able to identify when multiplication is the appropriate operation to use to solve a given problem. Assessment of whether a pupil has mastered multiplication sufficiently to progress to year 6 should also include questions which require other operations to solve.

5MD–4 Divide using a formal written method

Divide a number with up to 4 digits by a one-digit number using a formal written method, and interpret remainders appropriately for the context.

5MD–4 Teaching guidance

Pupils should learn to divide multi-digit numbers by one-digit numbers using the formal written method of short division. They should begin with examples that do not involve exchange, such as the two-digit ÷ one-digit calculation shown below. Pupils should learn that division is the only operation for which the formal algorithm begins with the most significant digit (on the left). When pupils first learn about short division, place-value equipment (such as place-value counters) should be used to model the algorithm and help pupils relate it to what they already know about division. They should understand that short division is based on the distributive property of multiplication which they learnt about in year 4 (4MD–3).

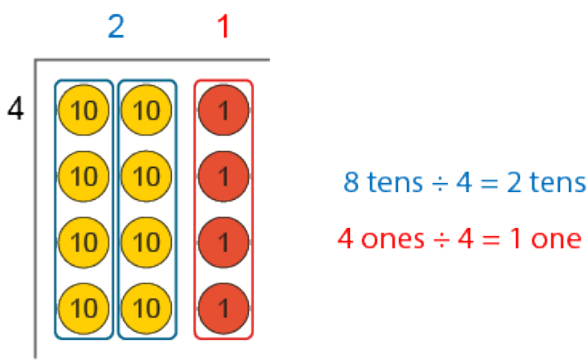
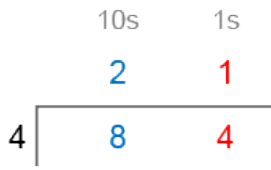
Short division with place-value counters	Short division
 <p>8 tens ÷ 4 = 2 tens 4 ones ÷ 4 = 1 one</p> <p>Figure 29: dividing 84 by 4 using short division with place-value counters</p>	 <p>Figure 30: dividing 84 by 4 using short division with place-value headings</p>

Initially, pupils should use unitising language to help them understand and apply short division.

Language focus

“8 tens divided by 4 is equal to 2 tens: write 2 in the tens column.”

“4 ones divided by 4 is equal to 1 one: write 1 in the ones column.”

Pupils may also use place-value headings while they learn to use the formal written method, as illustrated above. However, by the end of year 5, pupils must be able to use the short division algorithm without using unitising language and place-value headings.

Once pupils have mastered the basic principles of short division without exchange, they must learn to use the algorithm where exchange is required, for division of numbers with up to 4 digits by one-digit numbers. Pupils can again use unitising language, now for support with exchange, until they are able to apply the algorithm fluently.

$$\begin{array}{r} 153 \\ 4 \overline{) 612} \end{array}$$

Figure 31: dividing 612 by 4 using short division

6 hundreds ÷ 4	=	1 hundred remainder 2 hundreds
2 hundreds	=	20 tens
plus 1 more ten	=	21 tens
21 tens ÷ 4	=	5 tens remainder 1 ten
1 ten	=	10 ones
plus 2 more ones	=	12 ones
12 ones ÷ 4	=	3 ones

Pupils must be able to use short division to solve contextual division problems with:

- the quotitive structure (see [5MD–4 Example assessment questions](#), questions 5 and 8)
- the partitive structure (see [5MD–4 Example assessment questions](#), questions 2, 6 and 7)

Pupils should also be able to use short division to find unit fractions of quantities, and to solve missing-factor problems (for example, $? \times 5 = 1,325$) and missing-divisor problems (for example, $952 \div ? = 7$).

Pupils must be able to carry out short division calculations that involve a remainder and, for contextual problems, interpret the remainder appropriately as they learnt to do in year 4 (**4NF–2**).

Pupils must learn that, although short division can be used to divide any number by a one-digit number, it is not always the most appropriate choice. For example, $804 \div 4$, can be calculated mentally by partitioning, dividing and adding the partial quotients ($804 \div 4 = 200$, plus 1 more).

You can find out more about recording and fluency for these calculations here in the calculation and fluency section: [5MD–4](#)

Making connections

Pupils must be fluent in division facts corresponding to the multiplication tables (**5NF-1**) before they begin this criterion. Pupils should be able to use short multiplication (**5MD-3**) to check their short division calculations, and vice versa. Pupils should be able to use short division, where appropriate, to find a unit fraction of a quantity, and as the first step in finding a non-unit fraction of a quantity (**5F-1**).

5MD-4 Example assessment questions

1. Fill in the missing numbers.

$$4,728 \div 8 = \square$$

$$952 \div \square = 7$$

$$\square \times 5 = 1,325$$

$$176 = 4 \times \square$$

2. I have $1\frac{1}{2}$ litres of juice which I need to share equally between 6 glasses. How many millilitres of juice should I pour into each glass?
3. A school fair raises £5,164. The school keeps $\frac{1}{4}$ of the money for new playground equipment and gives the rest to charity. How much money does the school keep?
4. Fryderyk has saved 4 times as much money as his sister Gabriel. If Fryderyk has saved £348, how much has Gabriel saved?
5. A farmer has 3,150 eggs to pack into boxes of 6. How many boxes does she need?
6. Sharif wants to walk a long distance, for charity, over 6 weekends. The total distance Sharif wants to walk is 293km. Approximately how far should he walk each weekend?
7. Maria makes 1,531g of cake mix. She puts 250g into a small cake tin and wants to share the rest equally between 3 large cake tins. How many grams of cake mix should she put in each large cake tin?
8. 174 children are going on a trip. 4 children can fit into each room in the hostel. How many rooms are needed?
9. Fill in the missing numbers.

$$\begin{array}{r} \\ \square \overline{) 2,721^5 1^4 5^3} \end{array}$$

$$\begin{array}{r} \\ 7 \overline{) 1,\square12^2 5^1 6^0} \end{array}$$

10. David writes:

$$785 \times 9 = 7,065$$

Use short division to check whether David's calculation is correct.

Assessment guidance: Pupils need to be able to identify when division is the appropriate operation to use to solve a given problem. Assessment of whether a pupil has mastered division sufficiently to progress to year 6 should also include questions which require other operations to solve.

5F–1 Find non-unit fractions of quantities

Find non-unit fractions of quantities.

5F–1 Teaching guidance

Pupils should already be able to find unit fractions of quantities using known division facts corresponding to multiplication table facts (3F–2).

Language focus

“To find $\frac{1}{5}$ of 15, we divide 15 into 5 equal parts.”

“15 divided by 5 is equal to 3, so $\frac{1}{5}$ of 15 is equal to 3.”

By the end of year 5 pupils must be able to find unit and non-unit fractions of quantities, including for situations that go beyond known multiplication and division facts.

Pupils already understand the connection between a unit fraction of a quantity and dividing that quantity by the denominator. Now they should learn to reason about finding a non-unit fraction of a quantity, using division (to find the unit fraction) then multiplication (to find multiples of the unit fraction), and link this to their understanding of parts and wholes. Initially, calculations should depend upon known multiplication and division facts, so that pupils can focus on reasoning.

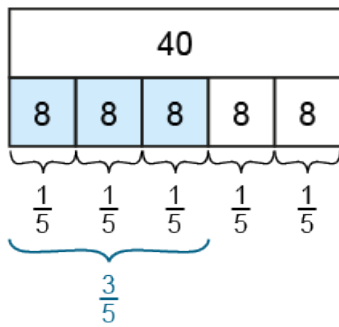

$$40 \div 5 = 8$$

$$\text{So, } \frac{1}{5} \text{ of } 40 = 8$$

$$8 \times 3 = 24$$

$$\text{So, } \frac{3}{5} \text{ of } 40 = 24$$

Figure 32: bar model to support finding three-fifths of 40

Language focus

“Three-fifths is equal to 3 one-fifths.”

“To find 3 one-fifths of 40, first find one-fifth of 40 by dividing by 5, and then multiply by 3.”

Once pupils can carry out these calculations fluently, and explain their reasoning, they should extend their understanding to calculate unit and non-unit fractions of quantities for calculations that go beyond known multiplication table facts. For example, they should be able to:

- apply place-value understanding to known number facts to find $\frac{3}{7}$ of 210
- use short division followed by short multiplication to find $\frac{4}{9}$ of 3,411

Pupils should also be able to construct their own bar models to solve more complex problems related to fractions of quantities. For example:

Miss Reeves has some tangerines to give out during break-time. She has given out $\frac{5}{6}$ of the tangerines, and has 30 left. How many tangerines did Miss Reeves have to begin with?

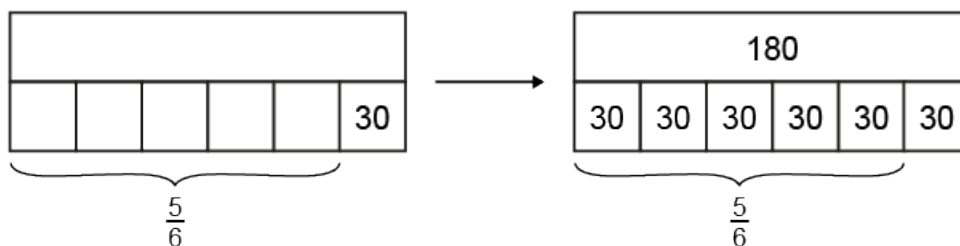

Figure 33: using a bar model to solve more complex problems related to fractions of quantities

Making connections

Pupils must be fluent in multiplication facts within the multiplication tables, and corresponding division facts (**5NF-1**). They must be able to confidently scale these facts by 10 or 100 (**3NF-3** and **4NF-3**) to find, for example, $\frac{3}{7}$ of 210. Pupils also need to be able to calculate using short multiplication (**5MD-3**) and short division (**5MD-4**) to be able to find, for example, $\frac{4}{9}$ of 3,411.

5F-1 Example assessment questions

1. Find:

$\frac{3}{8}$ of 32

$\frac{2}{9}$ of 45

$\frac{3}{5}$ of 30

$\frac{2}{7}$ of 630

$\frac{4}{9}$ of 315

$\frac{2}{5}$ of 3,500

$\frac{5}{8}$ of 2,720

1. Stan bought 15 litres of paint and used $\frac{2}{3}$ of it decorating his house. How much paint has he used?
2. My granny lives 120km from us. We are driving to see her and are $\frac{5}{6}$ of the way there. How far have we driven so far?
3. I am $\frac{3}{4}$ of the way through my holiday. I have 3 days of holiday left. How many days have I already been on holiday for?
4. A school is trying to raise £7,500 for charity. They have raised $\frac{5}{6}$ of the total so far. How much have they raised?
5. $\frac{4}{5}$ of the runners in a race have finished the race so far. If 92 people have finished, how many runners were in the race altogether?
6. There are 315 cows on a farm. $\frac{3}{5}$ of the cows are having calves this year. How many cows are not having calves?

5F–2 Find equivalent fractions

Find equivalent fractions and understand that they have the same value and the same position in the linear number system.

5F–2 Teaching guidance

Pupils must understand that more than one fraction can describe the same portion of a quantity, shape or measure. They should begin with an example where one of the fractions is a unit fraction, and the connection to the equivalent fraction uses known multiplication table facts.

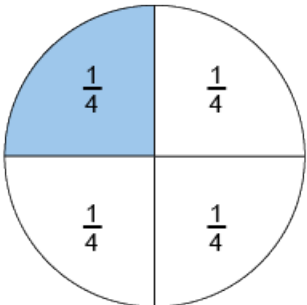
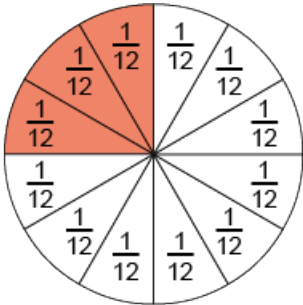
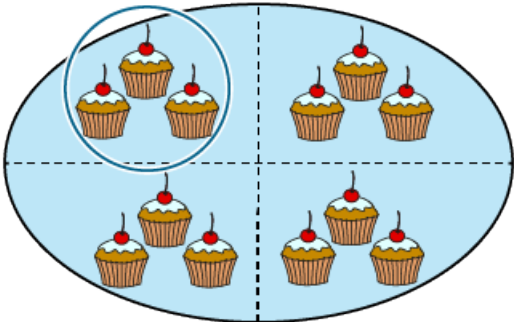
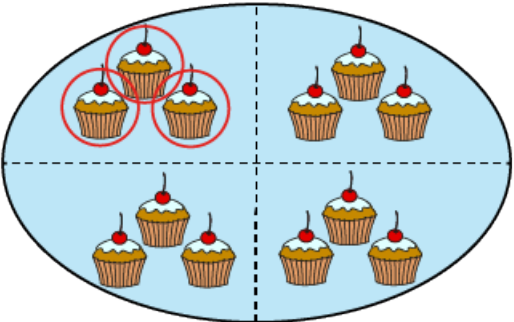
$\frac{1}{4}$	$\frac{3}{12}$
	
<p>Figure 34: circle divided into 4 equal parts with 1 part shaded</p>	<p>Figure 35: circle divided into 12 equal parts with 3 parts shaded</p>
<p>Language focus</p> <p>“The whole is divided into 4 equal parts and 1 of those parts is shaded.”</p>	<p>Language focus</p> <p>“The whole is divided into 12 equal parts and 3 of those parts is shaded.”</p>
	
<p>Figure 36: diagram showing that $\frac{1}{4}$ of 12 cakes is equal to 3 cakes</p>	<p>Figure 37: diagram showing that $\frac{3}{12}$ of 12 cakes is equal to 3 cakes</p>

$$\frac{1}{4} = \frac{3}{12}$$

Pupils should learn that 2 different fractions describing the same portion of the whole share the same position on a number line, have the same numerical value and are called equivalent fractions.

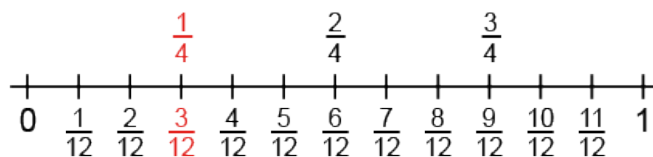

Figure 38: number line showing that $\frac{1}{4}$ and $\frac{3}{12}$ are equivalent

Pupils need to understand that equivalent fractions, such as $\frac{1}{4}$ and $\frac{3}{12}$, have the same numerical value because the numerator and denominator within each fraction have the same proportional relationship. In each case the numerator is $\frac{1}{4}$ of the denominator (and the denominator is 4 times the numerator).

Language focus

“ $\frac{1}{4}$ and $\frac{3}{12}$ are equivalent because 1 is the same portion of 4 as 3 is of 12.”

Attending to the relationship between the numerator and denominator will prepare pupils for comparing fractions with different denominators in year 6 (**6F–3**). Pupils should also be able to identify the multiplicative relationship between the pair of numerators, and understand that it is the same as that between the pair of denominators.

Pupils should learn to find equivalent fractions of unit fractions by using one of these multiplicative relationships (the ‘vertical’ relationship between the numerator and denominator, or the ‘horizontal’ relationship between the pairs of numerators and denominators).

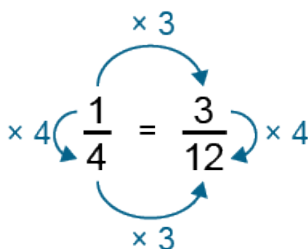

Figure 39: diagram showing the multiplicative relationships between the numerators and denominators in $\frac{1}{4}$ and $\frac{3}{12}$

In a similar way, pupils must then learn to find equivalent fractions of non-unit fractions, for example, $\frac{3}{5} = \frac{6}{10}$ or $\frac{3}{12} = \frac{8}{32}$.

Making connections

Pupils must be fluent in multiplication facts within the multiplication tables, and corresponding division facts (**5NF-1**). Being able to find unit and non-unit fractions of a quantity (**5F-1**) helps pupils to see that equivalent fractions have the same value.

5F-2 Example assessment questions

1. Find different ways to write the fraction of each shape or quantity that is shaded or highlighted.

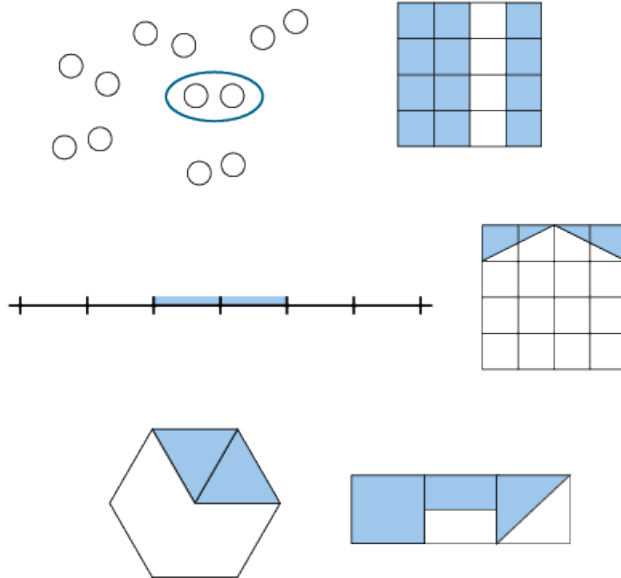

2. Draw lines to match the unit fractions on the left with their equivalent fractions on the right.

$$\frac{1}{5}$$

$$\frac{3}{12}$$

$$\frac{1}{4}$$

$$\frac{4}{20}$$

$$\frac{1}{3}$$

$$\frac{3}{9}$$

3. Mark each fraction on the number line.

$$\frac{9}{24} \quad \frac{36}{48} \quad \frac{12}{16} \quad \frac{10}{40} \quad \frac{9}{72}$$

Hint: convert each fraction to an equivalent fraction with a denominator of 8.

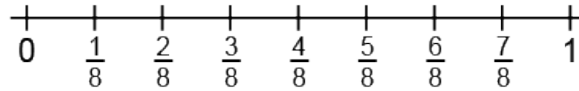

4. Use the numbers 3, 24, 8 and 1 to complete this chain of equivalent fractions.

$$\frac{2}{6} = \frac{\square}{\square} = \frac{\square}{\square}$$

5. Fill in the missing digits.

$$\frac{4}{8} = \frac{12}{\square}$$

$$\frac{3}{5} = \frac{\square}{40}$$

$$\frac{3}{\square} = \frac{21}{63}$$

$$\frac{20}{30} = \frac{\square}{15}$$

6. Fill in the missing number.

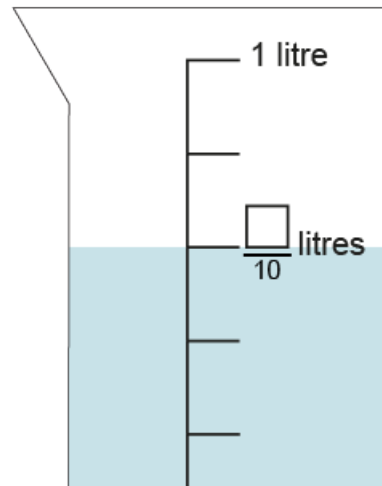
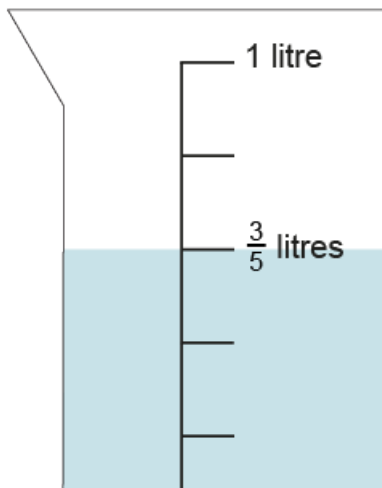

7. Sally and Tahira each have a 1m ribbon.

Sally cuts her ribbon into 5 equal parts and uses 1 of them to make a hair tie.

Tahira cuts her ribbon into 10 equal parts and uses 3 of them to make a bracelet.

Have Sally and Tahira used the same amount of ribbon? Explain your answer.

5F–3 Recall decimal equivalents for common fractions

Recall decimal fraction equivalents for $\frac{1}{2}$, $\frac{1}{4}$, $\frac{1}{5}$ and $\frac{1}{10}$, and for multiples of these proper fractions.

5F–3 Teaching guidance

Pupils know that both proper fractions and decimal fractions can be used to represent values between whole numbers. They now need to learn that the same value can be represented by both a decimal fraction and a proper fraction, and be able to recall common equivalents, beginning with unit fractions.

Unit fraction	Decimal fraction
$\frac{1}{2}$	0.5
$\frac{1}{4}$	0.25
$\frac{1}{5}$	0.2
$\frac{1}{10}$	0.1

Pupils should also be able to explain the equivalencies. A shaded hundred grid is a useful representation here.

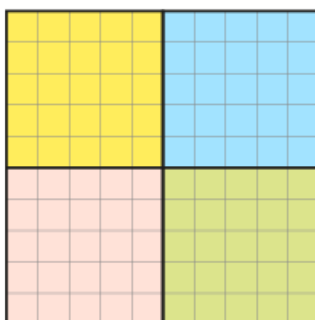

Figure 40: hundred grid divided into 4 equal parts: $\frac{1}{4}$ is equal to 25 hundredths

$$\frac{1}{4} = \frac{25}{100} = 0.25$$

Pupils should then extend their understanding and automatic recall to multiples of these unit fractions/decimal fractions, up to 1.

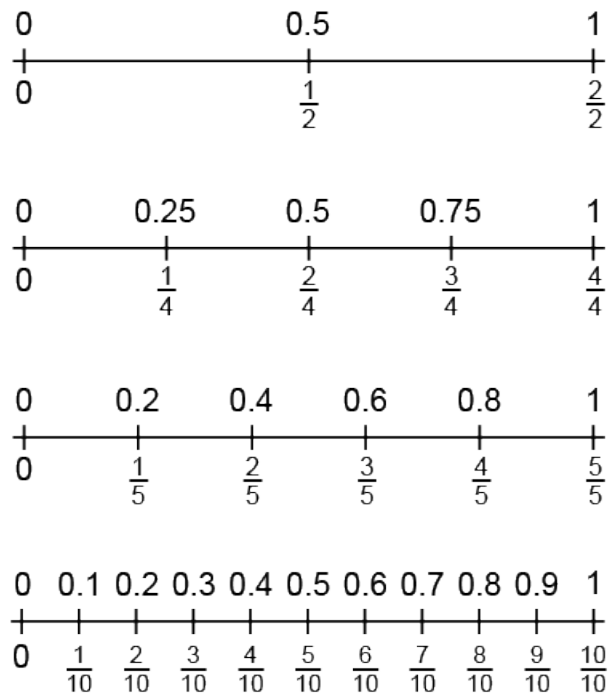

Figure 41: 0 to 1 number lines illustrating common proper fraction – decimal fraction equivalents

Pupils must be able to use these common equivalents with little effort, applying them to solve comparison and measures problems such as those shown in the example assessment questions. For a given problem, posed using a mixture of decimal fractions and proper fractions, pupils should be able to make a sensible decision about whether to carry out the calculation using decimal fractions or proper fractions.

Finally, pupils need to extend this knowledge beyond the 0 to 1 interval. They should know for example that 3.2km and $3\frac{1}{5}$ km are 2 different ways of writing the same distance.

Making connections

This criterion builds on [5NPV-4](#), where pupils learnt to divide 1 into 2, 4, 5 or 10 equal parts and to read scales marked in multiples of multiples of 0.1, 0.2, 0.25 or 0.5.

Criterion [5NPV-5](#) requires pupils to convert between units of measure, including using the common decimal fraction and proper fraction equivalents in this criterion.

5F–3 Example assessment questions

1. Fill in the missing symbols (<, > or =).

$$\frac{1}{10} \square 0.75$$

$$0.4 \square \frac{1}{4}$$

$$0.5 \square \frac{1}{5}$$

$$\frac{3}{4} \square 0.75$$

$$0.8 \square \frac{4}{5}$$

$$\frac{1}{2} \square 0.2$$

2. Write these measurements as mixed numbers.

1.2km

5.75m

25.5kg

3. Write these measurements as decimals.

$1\frac{1}{4}$ litres

$10\frac{1}{2}$ cm

$4\frac{4}{5}$ m

4. My brother weighs 27.3kg. I weigh $27\frac{1}{2}$ kg. How much more than my brother do I weigh?

5. Year 6 set off on a $2\frac{3}{4}$ km woodland walk. By lunch, they had walked 1.75km. How much further do they need to walk?

6. Here are two parcels:

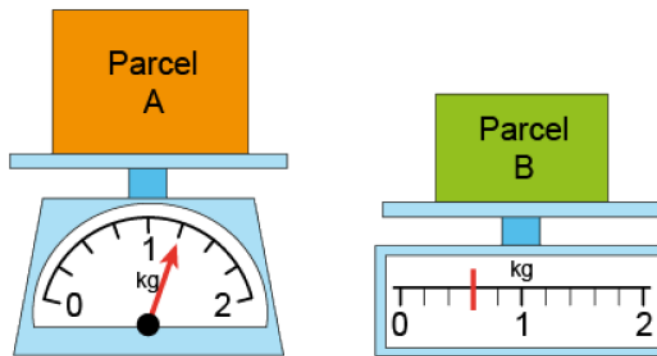

What is the total combined weight of the parcels, in kilograms?

7. Put each set of numbers in order from smallest to greatest.

a. 1.4 $4\frac{1}{4}$ 4.1 4.4

b. $3\frac{1}{5}$ 3.5 $1\frac{3}{5}$ 1.3

5G–1 Compare, estimate, measure and draw angles

Compare angles, estimate and measure angles in degrees ($^{\circ}$) and draw angles of a given size.

5G–1 Teaching guidance

In year 3, pupils learnt to identify right angles and to determine whether a given angle is larger or smaller than a right angle (**3G–1**). Pupils should now compare angles, including the internal angles of polygons, and be able to identify the largest and smallest angles when there is a clear visual difference. Pupils should be able to use the terms acute, obtuse and reflex when describing and comparing angles, and use conventional markings (arcs) to indicate angles.

Language focus

“An acute angle is smaller than a right angle.”

“An obtuse angle is larger than a right angle but less than the angle on a straight line.”

“A reflex angle is larger than the angle on a straight line, but less than the angle for a full turn.”

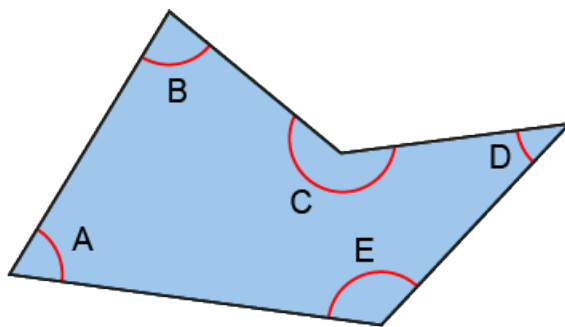

Figure 42: irregular pentagon with 3 acute internal angles, 1 obtuse internal angle and 1 reflex internal angle

Language focus

“D is the smallest angle. It is an acute angle.”

“C is the largest angle. It is a reflex angle.”

Pupils must learn that we can measure the size of angles just as we can measure the length of sides. They should learn that the unit used is called degrees and indicated by the $^{\circ}$ symbol. Pupils should know that there are 360° in a full turn, 90° in a quarter turn or right angle, and 180° in a half turn or on a straight line.

Pupils must know that the position of the arc indicating an angle does not affect the size of the angle, which is determined by the amount of turn between the two lines. Similarly, they should know that the length of the lines does not affect the size of the angle between them.

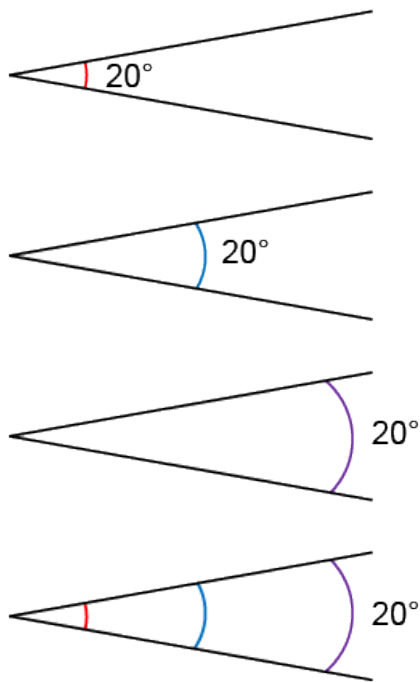

Figure 43: the position of the arc indicating an angle does not affect the size of the angle

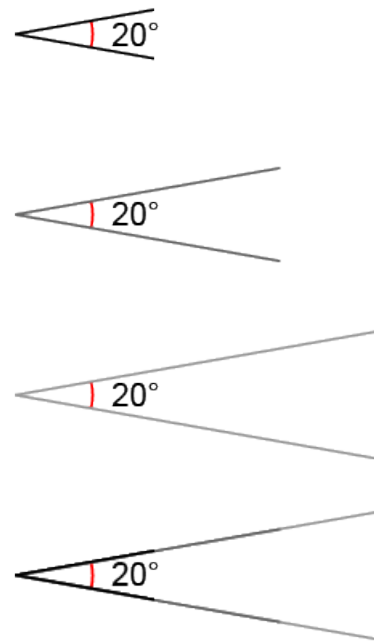

Figure 44: the length of the lines does not affect the size of the angle between them

Before pupils learn to use protractors, they should learn to estimate and approximate common angles, and angles that are close to them, including 90° , 180° , other multiples of 10° , and 45° . They should use sets of 'standard angle' measuring tools (for example, cut out from card) for support in approximating, and to check estimates.

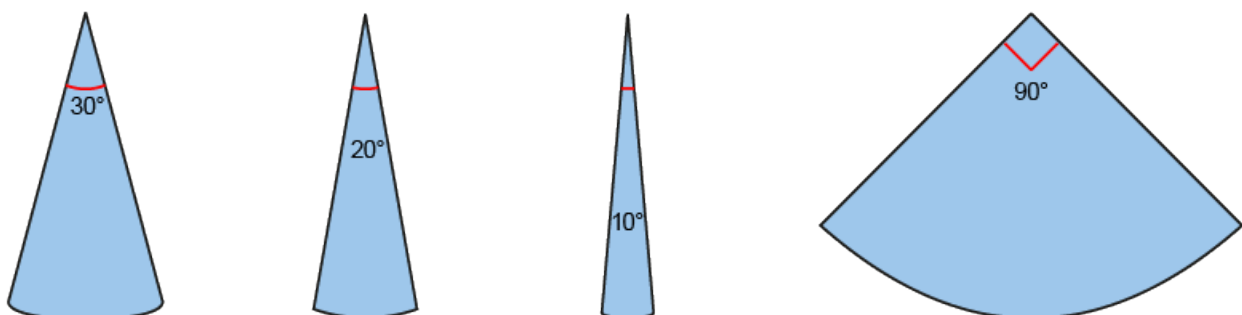

Figure 45: a selection of 'standard angle' measuring tools

Once pupils can make reasonable estimates of angle size, they must learn to make accurate measurements, using a protractor, for angles up to 180° . It is good practice to make an estimate before taking an accurate measurement, and pupils should use learn to use their estimates for support in reading the correct value off the protractor.

Pupils should also, now, be able to use the more formal definitions of acute, obtuse and reflex.

Language focus

“An acute angle is less than 90° .”

“An obtuse angle is greater than 90° but less than 180° .”

“A reflex angle is greater than 180° but less than 360° .”

5G–1 Example assessment questions

Do not use a protractor for questions 1, 2 and 3.

1. Here is an irregular pentagon.

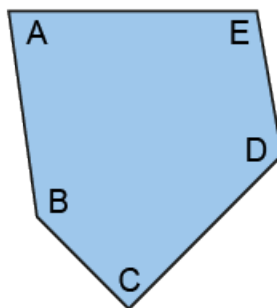

- Which is the largest angle in this pentagon?
- Which is the smallest angle?
- Which angle is 100° ?

2. Here are 6 angles.

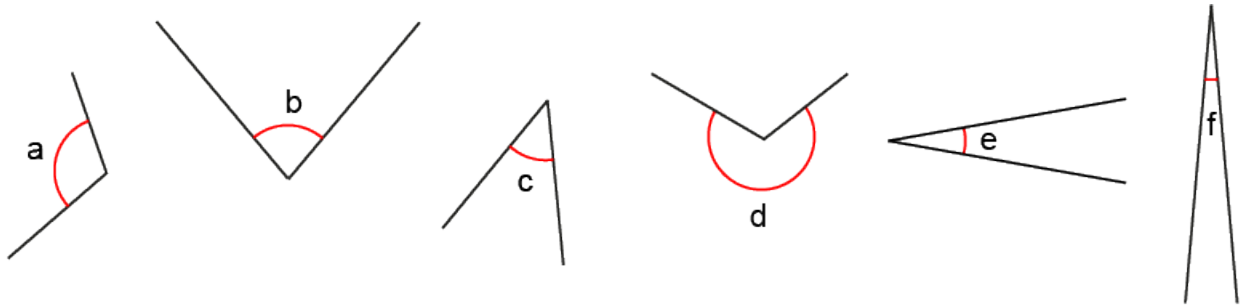

- Which is the largest angle?
- Which is the smallest angle?
- Which angle is 45° ?

3. This pentagon has a line of symmetry. Estimate the size of each angle.

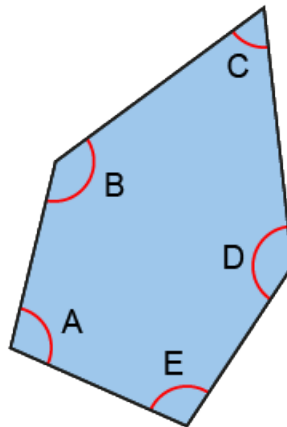

4. Measure and label each of the angles in these shapes using a protractor.

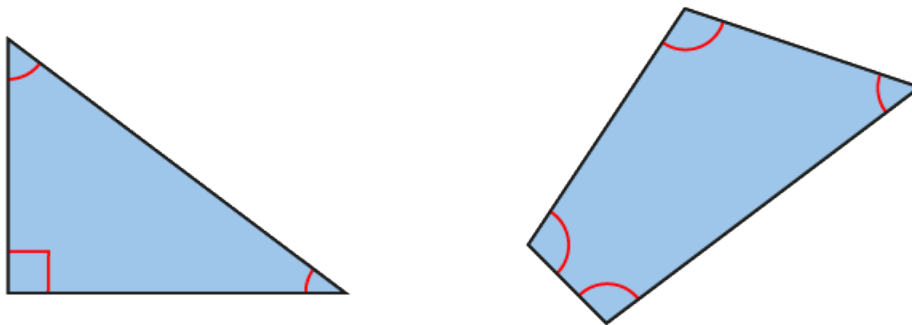

- Draw an angle of 68° .
- Draw an angle of 103° .

5G–2 Compare and calculate areas

Compare areas and calculate the area of rectangles (including squares) using standard units.

5G–2 Teaching guidance

Pupils need to know that the area of a shape is the space within a shape. When there is a clear visual difference, pupils should be able to compare the area of shapes without making a quantitative evaluation of each area. For example, pupils can see that the circle has a larger area than the decagon.

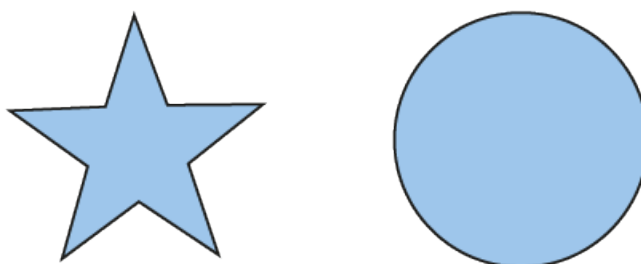

Figure 46: a decagon and a circle with a clear visual difference in area

Pupils should learn that, when there is not a clear visual difference between areas, a common unit can be used to quantify the areas and enable comparison. They should understand that any unit can be used, but that the square centimetre (cm^2) is the standard unit of measure for area that they will use most frequently. Pupils should gain a sense of the size of a square centimetre, and the notation used, before they begin to quantify other areas using this unit.

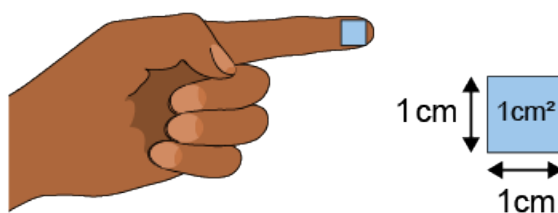

Figure 47: a square centimetre

Pupils need to be able to find the area of shapes drawn on square-centimetre grids by counting squares, including shapes for which some of the area is made up of half-squares. They should understand that different shapes can have the same area.

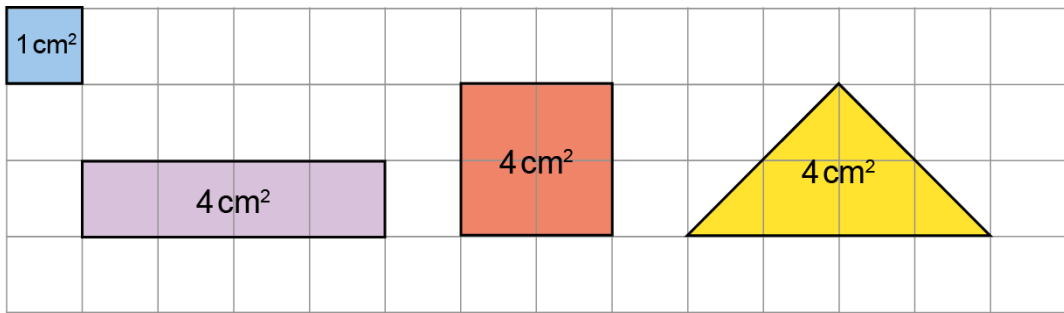

Figure 48: a rectangle, square and triangle with equal areas

Drawn to actual size.

Pupils should then learn that the area of a rectangle can be calculated by multiplying the length by the width. They should learn why this is the case by examining rectangles drawn on square-centimetre grids, and understand that the factors can be written in either order: the area of the rectangle below is equal to 4 rows of 5 square centimetres, or 5 columns of 4 square centimetres. This should build on pupils understanding of the grouping structure of multiplication and array representations.

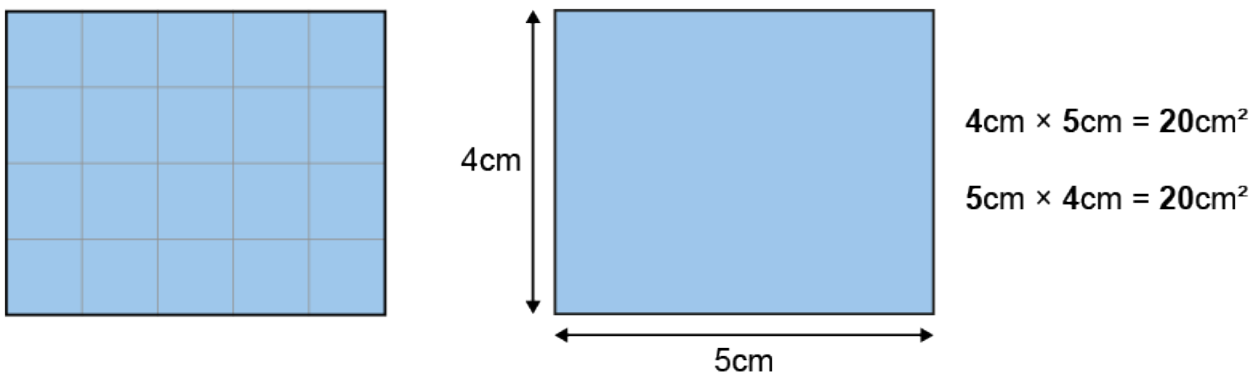

Figure 49: the area of a rectangle can be calculated by multiplying the length by the width

Drawn to actual size.

Language focus

“To find the area of a rectangle, multiply the length by the width.”

Pupils should learn that the area of larger shapes and spaces, such as the floor or ceiling of the classroom, or the playground, is expressed in square metres (m^2). Pupils should experience working with large spaces directly, as well as drawings representing them.

Making connections

Pupils must be able to multiply two numbers together in order to calculate the area of a rectangle, including:

- known multiplication facts within the multiplication tables (**5NF-1**) (for example, to calculate the area of a 9cm by 4cm rectangle)
- scaling known multiplication facts by 10 or 100 (**3NF-3**, **4NF-3** and **5NF-2**) (for example, to calculate the area of a 0.2m \times 3m rectangle or a 20m \times 3m rectangle)
- other mental or written methods (for example, to calculate the area of a 15cm \times 8cm rectangle)

5G-2 Example assessment questions

1. For each pair of shapes, tick the shape with the larger shaded area.

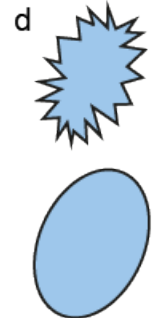
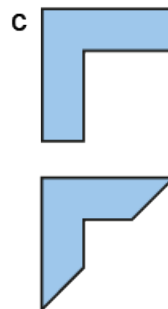
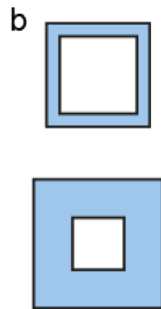
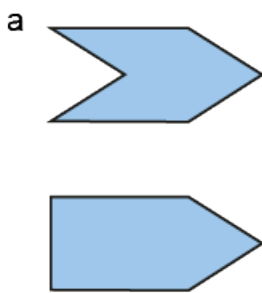

2. Find the area of these shapes drawn on a square-centimetre grid.

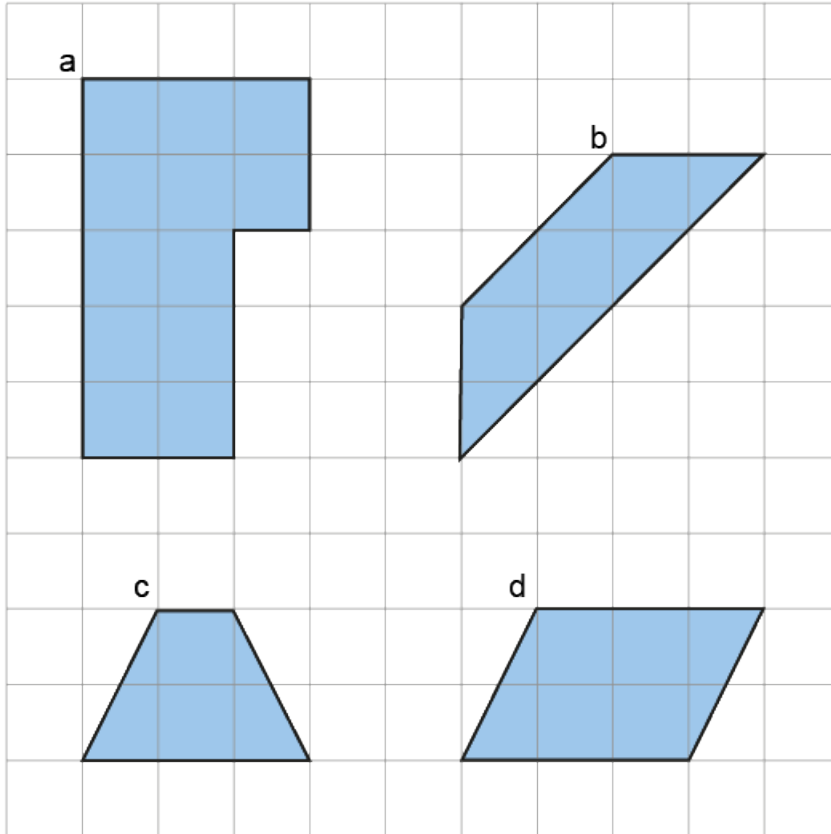

Drawn to actual size.

3. Here are three shapes on a triangular grid. Put the shapes in order from smallest to largest according to their area.

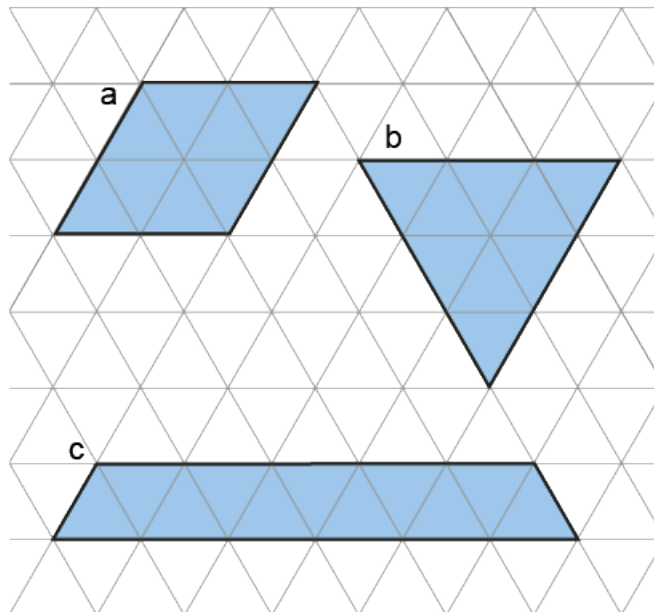

4. a. Draw a rectangle with an area of 12cm^2 on this square-centimetre grid.
 b. Draw a hexagon with an area of 12cm^2 on this square-centimetre grid.

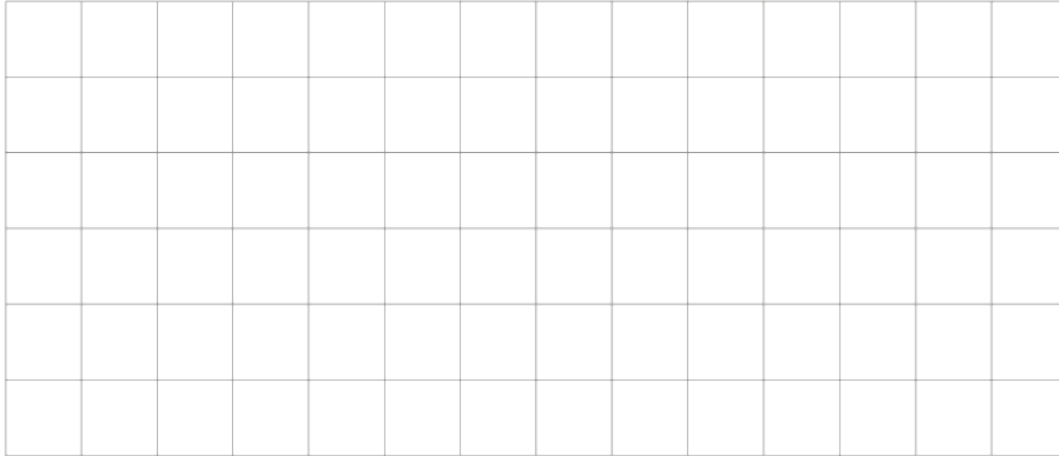

Drawn to actual size.

5. Find the area of each of these rectangles.

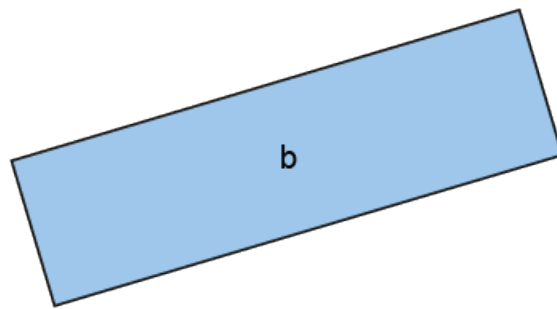
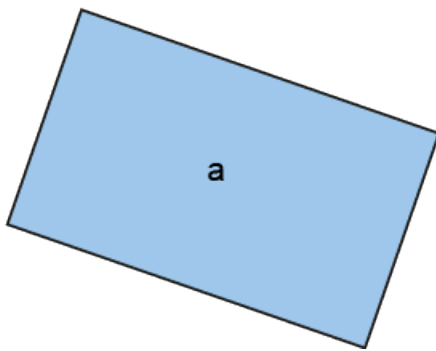

6. Leila is putting some tiles on the wall behind her kitchen sink. Each tile is square, with sides equal to 10cm.

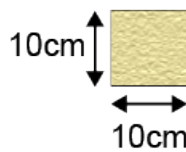

Here is the area she has tiled so far.

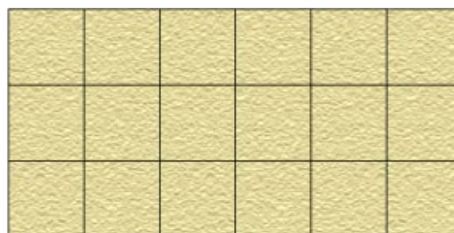

If Leila adds one more row of tiles on top of these ones, what is the total area she will have tiled?

7. Each half of a volleyball court is a $9\text{m} \times 9\text{m}$ square. What is the total area of a volleyball court?

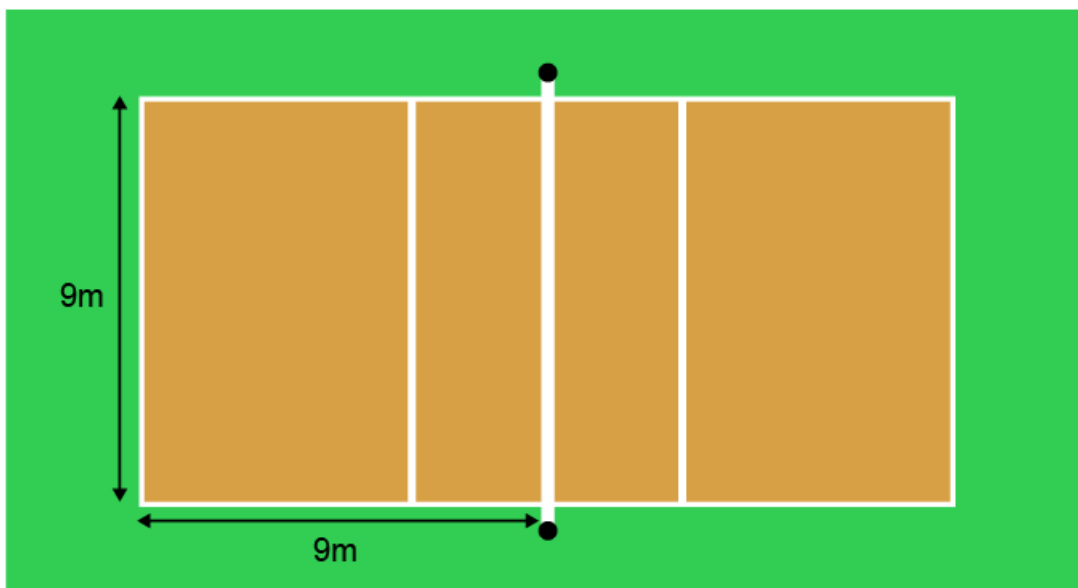

Drawn to scale.

8. Estimate the area of your classroom floor.

Calculation and fluency

Number, place value and number facts: 5NPV–2 and 5NF–2

- **5NPV–2** Recognise the place value of each digit in numbers with up to 2 decimal places, and compose and decompose numbers with up to 2 decimal places using standard and non-standard partitioning.
- **5NF–2** Apply place-value knowledge to known additive and multiplicative number facts (scaling facts by 1 tenth or 1 hundredth), for example:

$$8 + 6 = 14$$

$$0.8 + 0.6 = 1.4$$

$$0.08 + 0.06 = 0.14$$

$$3 \times 4 = 12$$

$$0.3 \times 4 = 1.2$$

$$0.03 \times 4 = 0.12$$

Representations such as place-value counters and partitioning diagrams (**5NPV-2**) and tens-frames with place-value counters (**5NF-2**) can be used initially to help pupils understand calculation strategies and make connections between known facts and related calculations. However, pupils should not rely on such representations for calculating. For the calculations in **5NF-2**, for example, pupils should instead be able to calculate by verbalising the relationship.

Language focus

“8 plus 6 is equal to 14, so 8 tenths plus 6 tenths is equal to 14 tenths.”

“14 tenths is equal to 1 one and 4 tenths.”

Pupils should maintain fluency in both formal written and mental methods for addition and subtraction. Mental methods can include jottings to keep track of calculation, or language structures as exemplified above. Pupils should select the most efficient method to calculate depending on the numbers involved.

Addition and subtraction: extending 3AS-3

Pupils should also extend columnar addition and subtraction methods to numbers with up to 2 decimal places.

Pupils must be able to add 2 or more numbers using columnar addition, including calculations whose addends have different numbers of digits.

$$\begin{array}{r}
 274.1 \\
 + 195.8 \\
 \hline
 469.9 \\
 \hline
 1
 \end{array}
 \qquad
 \begin{array}{r}
 47.52 \\
 + 81.7 \\
 \hline
 129.22 \\
 \hline
 1
 \end{array}
 \qquad
 \begin{array}{r}
 6.3 \\
 1.49 \\
 + 25.6 \\
 \hline
 33.39 \\
 \hline
 11
 \end{array}$$

Figure 50: columnar addition for calculations involving numbers with up to 2 decimal places

For calculations with more than 2 addends, pupils should add the digits within a column in the most efficient order. For the third example above, efficient choices could include:

- beginning by making 10 in the tenths column
- making double-6 in the ones column

Pupils must be able to subtract one number from another using columnar subtraction, including numbers with up to 2 decimal places. They should be able to apply the columnar method to calculations presented as, for example, $21.8 - 9.29$ or $58 - 14.69$, where the subtrahend has more decimal places than the minuend. Pupils must also be able to exchange through 0.

$$\begin{array}{r}
 21.8 - 9.29 \\
 \begin{array}{r}
 4 \overset{6}{\cancel{7}} \cdot 2 \overset{1}{6} \\
 - 1 \overset{5}{5} \cdot 8 \overset{3}{3} \\
 \hline
 3 \overset{1}{1} \cdot 4 \overset{3}{3}
 \end{array}
 \end{array}
 \qquad
 \begin{array}{r}
 21.8 - 9.29 \\
 \begin{array}{r}
 \overset{1}{2} \overset{1}{1} \cdot \overset{7}{8} \overset{1}{0} \\
 - \quad \quad 9 \cdot 2 \quad 9 \\
 \hline
 1 \overset{2}{2} \cdot 5 \overset{1}{1}
 \end{array}
 \end{array}
 \qquad
 \begin{array}{r}
 58 - 14.69 \\
 \begin{array}{r}
 \overset{7}{8} \overset{9}{0} \overset{1}{1} \cdot 7 \\
 - \quad 2 \quad 4 \quad 5 \cdot 3 \\
 \hline
 5 \overset{5}{5} \overset{6}{6} \cdot 4
 \end{array}
 \end{array}$$

Figure 51: columnar subtraction for calculations involving numbers with up to 2 decimal places

Pupils should make sensible decisions about how and when to use columnar methods. For example, when subtracting a decimal fraction from a whole number, pupils may be able to use their knowledge of complements, avoiding the need to exchange through zeroes. For example, to calculate $8 - 4.85$ pupils should be able to work out that the decimal complement to 5 from 4.85 is 0.15, and that the total difference is therefore 3.15.

5NF-1 Secure fluency in multiplication and division facts

Secure fluency in multiplication table facts, and corresponding division facts, through continued practice.

Pupils who have automatic recall of multiplication table facts and corresponding division facts have the best chance of mastering formal written methods. The facts up to 9×9 are required for calculation within the ‘columns’ during application of formal written methods, and all mental multiplicative calculation also depends on these facts.

Pupils will need regular practice of multiplication tables and associated division facts (including calculating division facts with remainders) to maintain the fluency they achieved by the end of year 4.

Pupils should also maintain fluency in related calculations including:

- scaling known multiplicative facts by 10 or 100 (**3NF-3** and **4NF-3**)
- multiplying and dividing by 10 and 100 for calculations that involve whole numbers only (**4MD-1**)

They should develop fluency in:

- scaling multiplicative facts by one-tenth or one-hundredth ([5NF-2](#))
- multiplying and dividing by 10 and 100, for calculations that bridge 1 ([5MD-1](#))

5MD-3 Multiply using a formal written method

Multiply any whole number with up to 4 digits by any one-digit number using a formal written method.

Pupils must be able to multiply whole numbers with up to 4 digits by one-digit numbers using short multiplication.

$$\begin{array}{r}
 24 \\
 \times 6 \\
 \hline
 144 \\
 2
 \end{array}
 \qquad
 \begin{array}{r}
 342 \\
 \times 7 \\
 \hline
 2394 \\
 21
 \end{array}
 \qquad
 \begin{array}{r}
 2,371 \\
 \times 4 \\
 \hline
 9,484 \\
 12
 \end{array}$$

Figure 52: short multiplication for multiplication of 2-, 3- and 4-digit numbers by one-digit numbers

Pupils should be fluent in interpreting contextual problems to decide when multiplication is the appropriate operation to use, including as part of multi-step problems. Pupils should use short multiplication when appropriate to solve these calculations. Examples are given in [5MD-3](#).

5MD-4 Divide using a formal written method

Divide a number with up to 4 digits by a one-digit number using a formal written method, and interpret remainders appropriately for the context.

Pupils must be able to divide numbers with up to 4 digits by one-digit numbers using short division, including calculations that involve remainders. Pupils do not need to be able to express remainders arising from short division, using proper fractions or decimal fractions.

$$\begin{array}{r}
 14 \\
 7 \overline{) 98}
 \end{array}
 \qquad
 \begin{array}{r}
 86r2 \\
 5 \overline{) 432}
 \end{array}
 \qquad
 \begin{array}{r}
 619 \\
 8 \overline{) 4952}
 \end{array}$$

Figure 53: short division for division of 2-, 3- and 4-digit numbers by one-digit numbers

Pupils should be fluent in interpreting contextual problems to decide when division is the appropriate operation to use, including as part of multi-step problems. Pupils should use short division when appropriate to solve these calculations. For contextual problems, pupils must be able to interpret remainders appropriately as they learnt to do in year 4 ([4NF-2](#)). Examples are given in [5MD-4](#) Example assessment questions

© Crown copyright 2020

This publication (not including logos) is licensed under the terms of the Open Government Licence v3.0 except where otherwise stated. Where we have identified any third party copyright information you will need to obtain permission from the copyright holders concerned.

To view this licence:

visit www.nationalarchives.gov.uk/doc/open-government-licence/version/3

email psi@nationalarchives.gsi.gov.uk

write to Information Policy Team, The National Archives, Kew, London, TW9 4DU

About this publication:

enquiries www.education.gov.uk/contactus

download www.gov.uk/government/publications

Reference: DfE-00100-2020



Follow us on Twitter:
[@educationgovuk](https://twitter.com/educationgovuk)



Like us on Facebook:
facebook.com/educationgovuk